

# CEILING PANELS

## FLAT

designed by ARS

The Acoustic Ceiling Panels Collection, made out of PET-Felt, improves the acoustic performance of any room by removing the existing panels while also enhancing the aesthetic aspects.

The smooth design of the Flat Panels adds design interest to the ceiling area without lowering the ceiling height. This is a great option for spaces with low ceilings.

# ASKÍA

[www.askiafurniture.ro](http://www.askiafurniture.ro)



# PRODUCT DETAILS

## Characteristics



Diffusion



Absorption

Weight	Material	Thickness	Applications
2400 g/mp	PET-Felt	12 mm/0.4 inch	Indoor areas only

## Color

Slight color deviations may occur since the PET Felt panels are made from recycled fibers. It is recommended to use the same batch per project. When placing an order take a margin into account for unforeseen changes or additions to a design plan.

### Standard

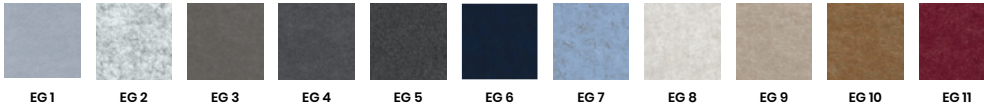

### Non-Standard\*

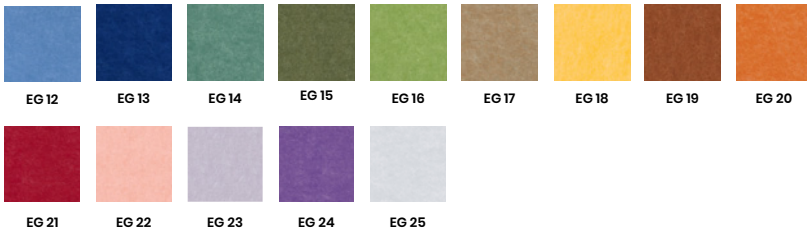

\*A minimum quantity order is required for non-standard colors.

## Fire Rating

B-s1, d0 classification

## Environment

ASKIA PET is 50% recycled  
ASKIA PET is 100% recyclable

## How to order



Consult your project area



Decide how many panels you need



Contact us for questions and order

\*Measurements are in millilitres/inches

## Installation

### Resting on grid

To install the panels, take out the old panels from the grid and insert the chosen design. Based on the design chosen, you can choose the orientation of the panels to create the different compositions.

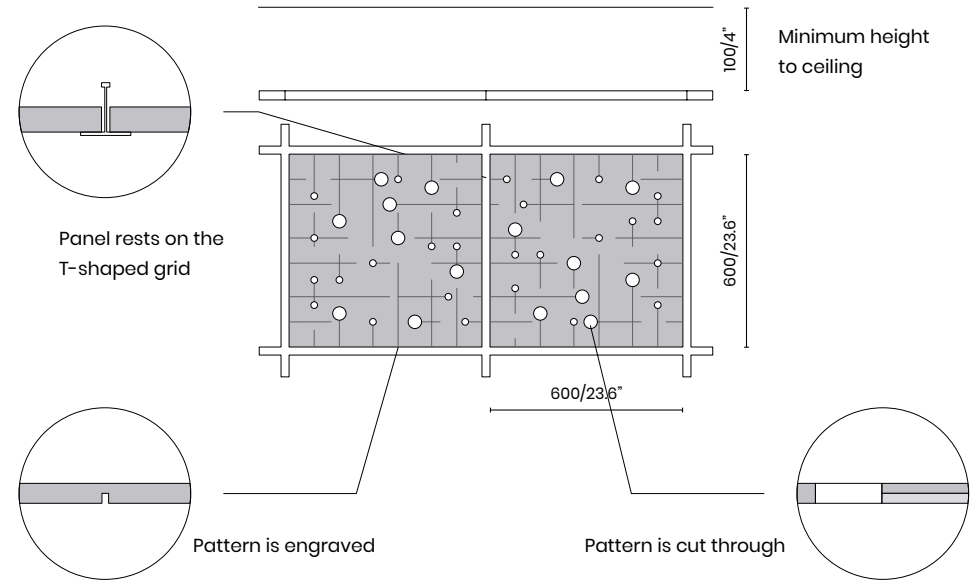

## Care Instructions

- Vacuum to remove dust.
- PET Felt is easy to clean and maintain. Most stains can be removed with plenty of water. Let the water drip through and blot the stain with a dry cloth.
- Never rub the PET Felt, as it can damage the material.
- If water is not sufficient, stubborn stains can be removed with professional cleaning products like the Dr. Beckmann

products. Depending on the type of stain, the Dr. Beckmann products provides different solutions. It is advised to try a cleaning product out on an invisible spot prior to its application on a visible area. Please, read the manufacturer's manual to choose the suitable type of treatment.

- Polyester carpet and fabric cleaners can be used. Always test an inconspicuous area first.

**FAVO**

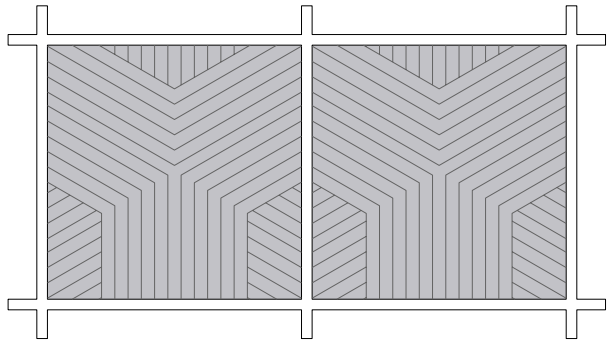

**LAYOUT EXAMPLE**

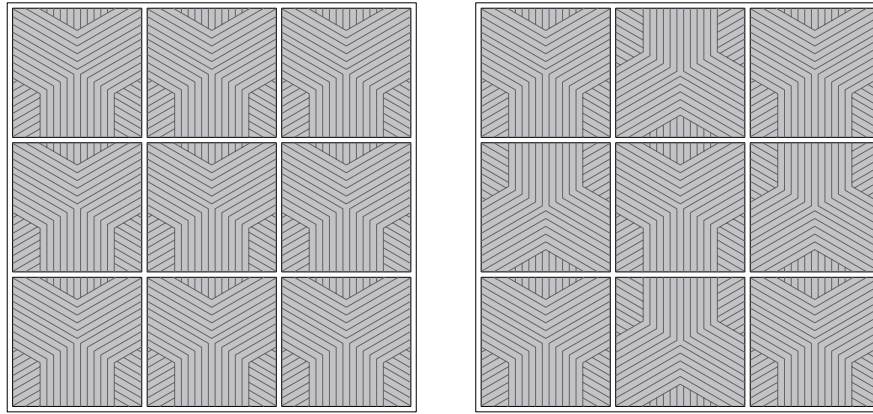

**VIA**

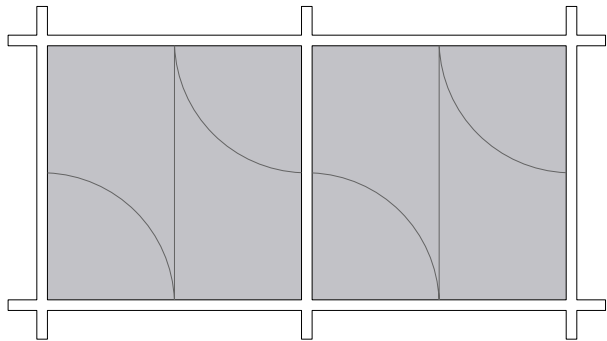

**LAYOUT EXAMPLE**

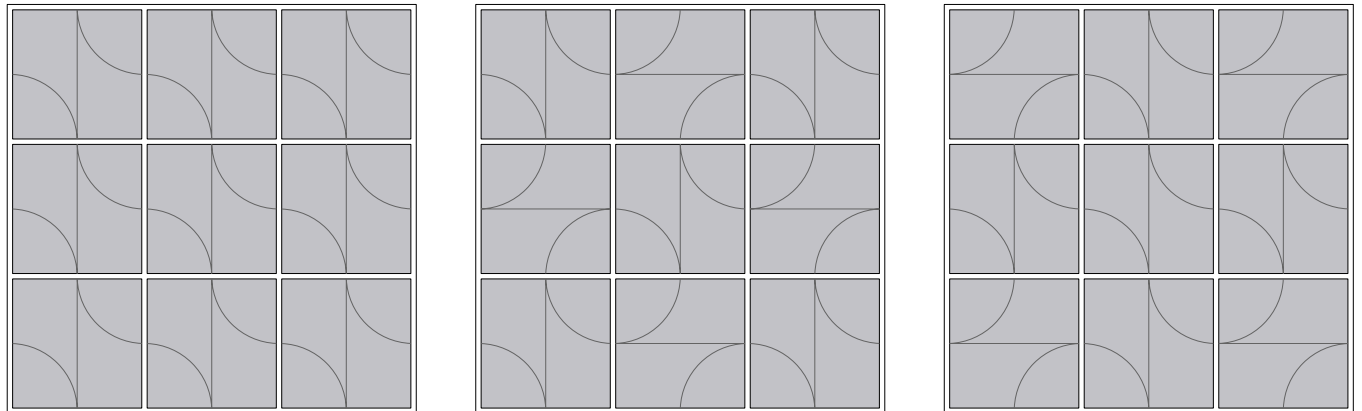

**INTERSECTIO**

---

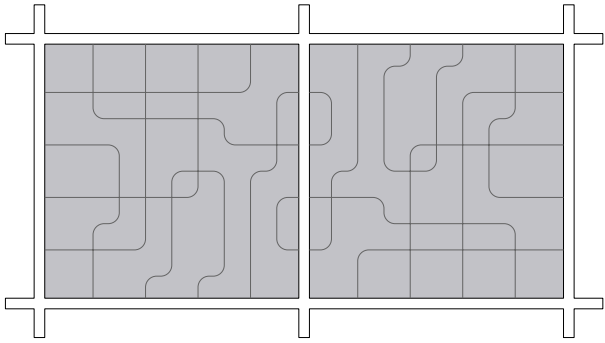

**LAYOUT EXAMPLE**

---

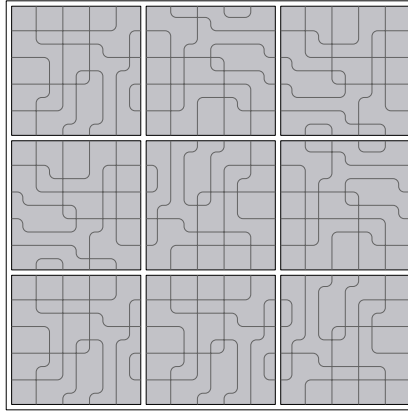

**IRIS**

---

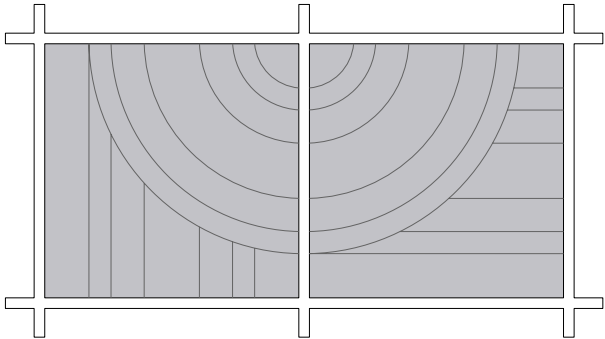

**LAYOUT EXAMPLE**

---

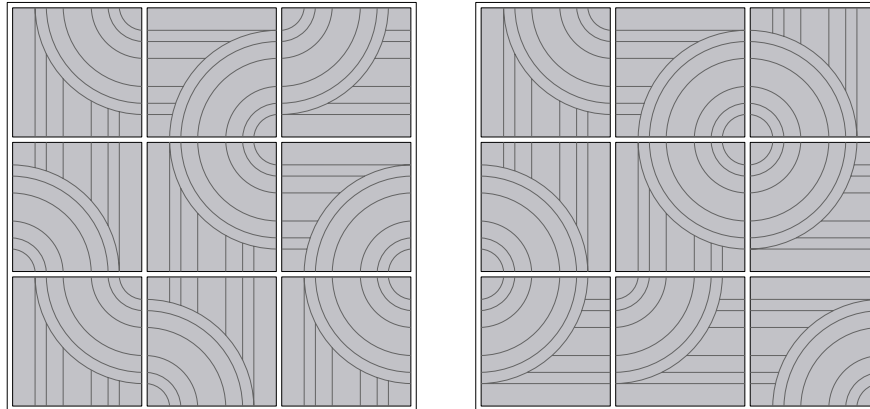

**ARCO 1**

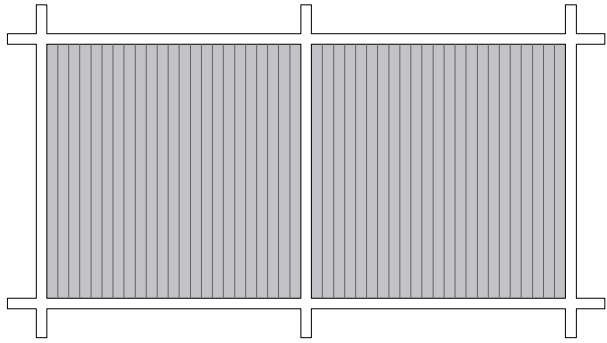

**LAYOUT EXAMPLE**

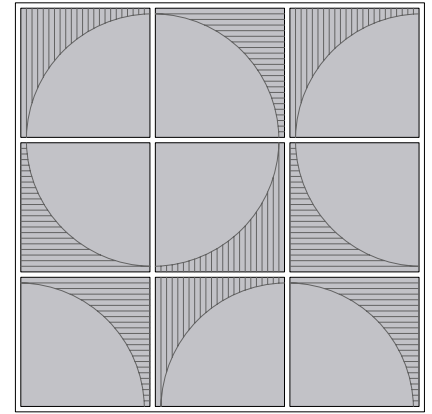
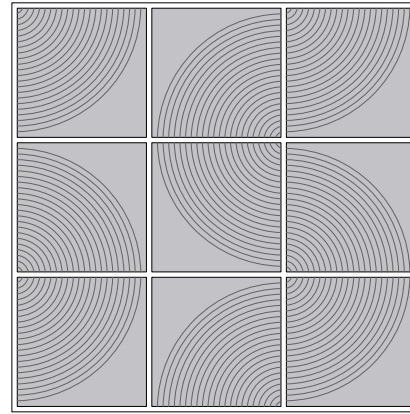
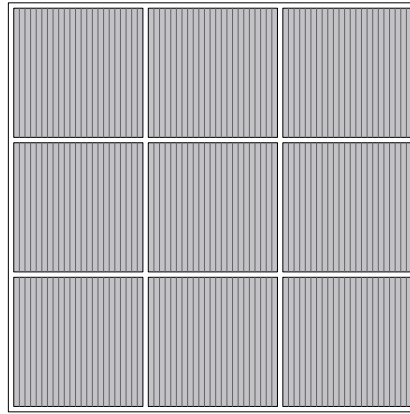

**ARCO 2**

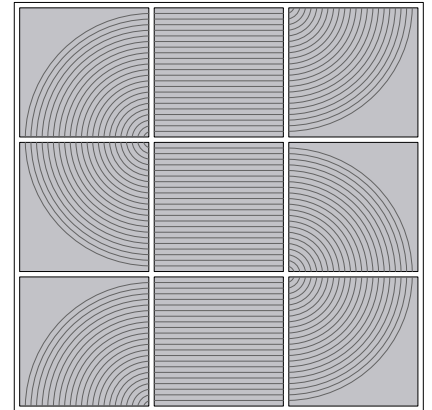
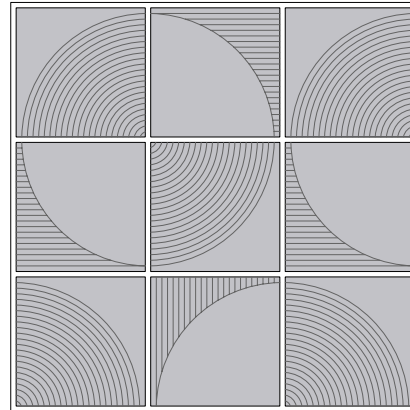
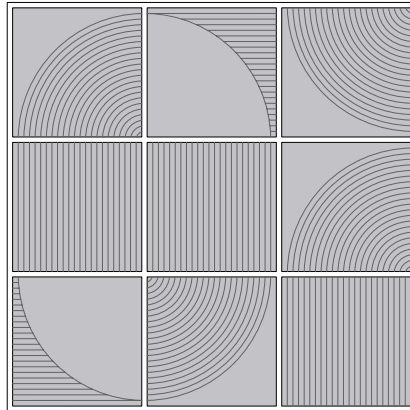
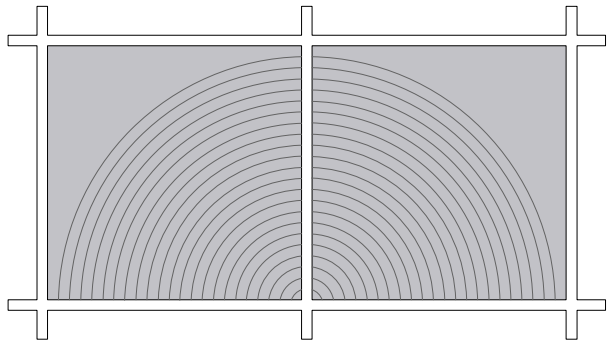

**ARCO 3**

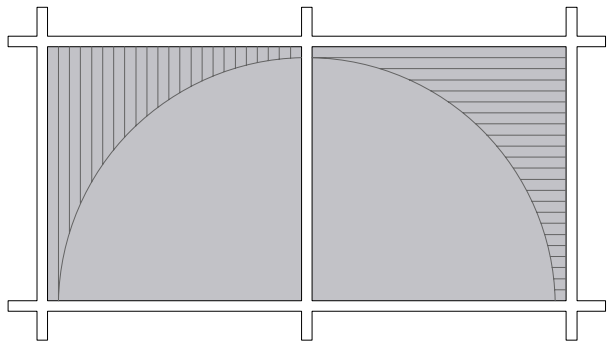

SOPRA 1

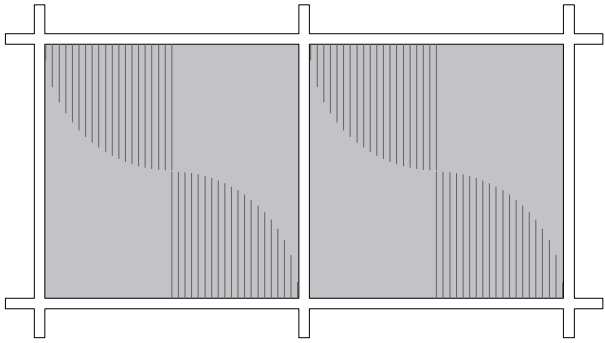

LAYOUT EXAMPLE

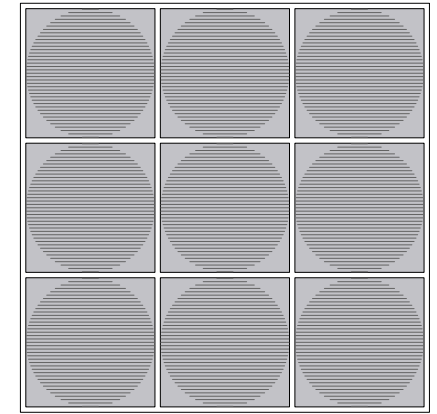
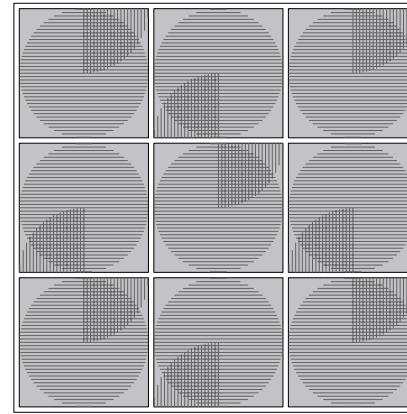
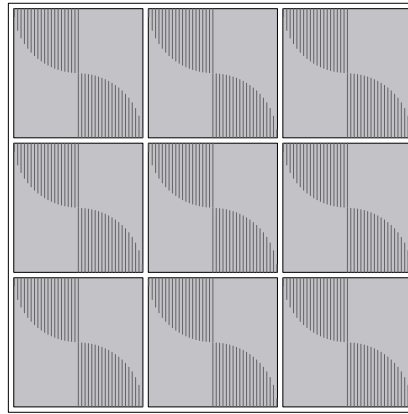

SOPRA 2

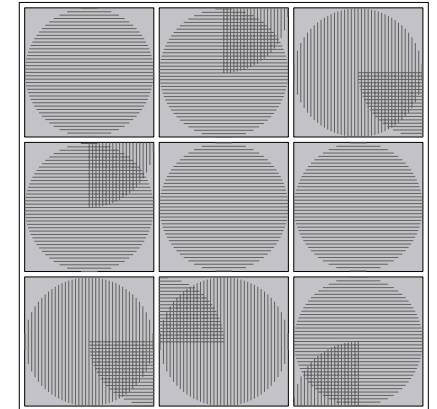
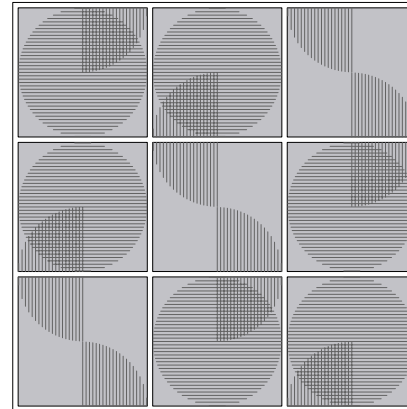
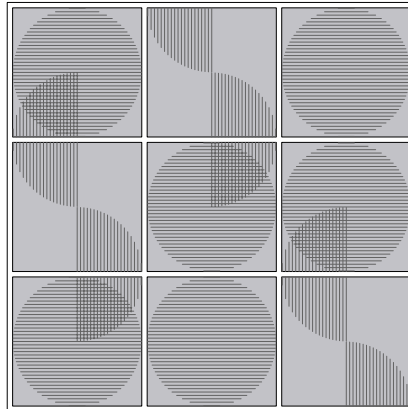
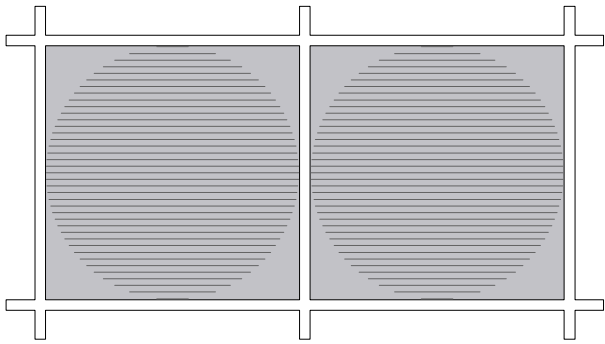

SOPRA 3

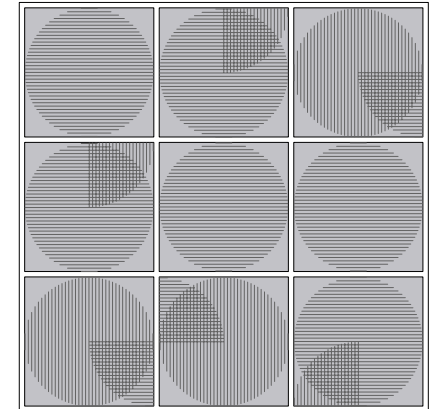
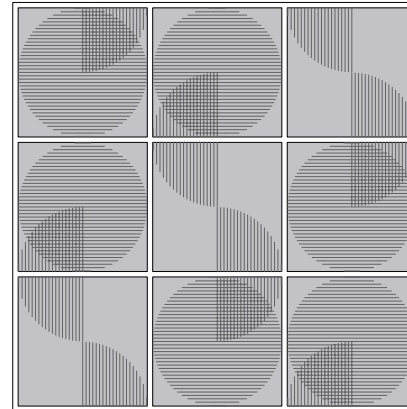
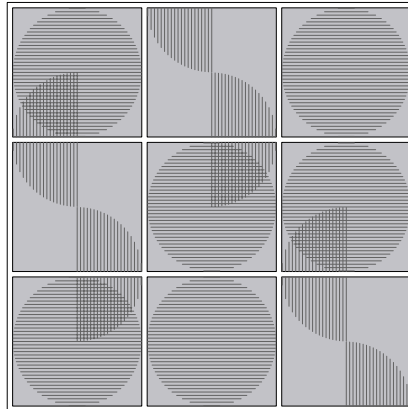
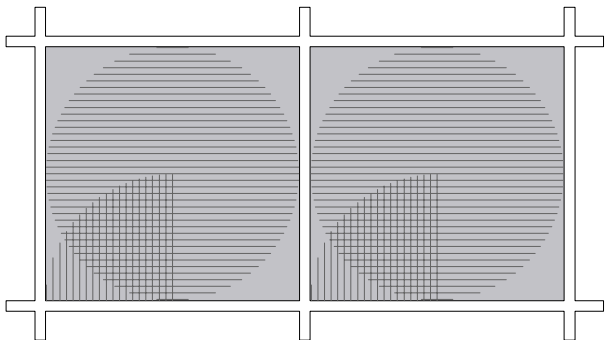



## ILLUSIO 1

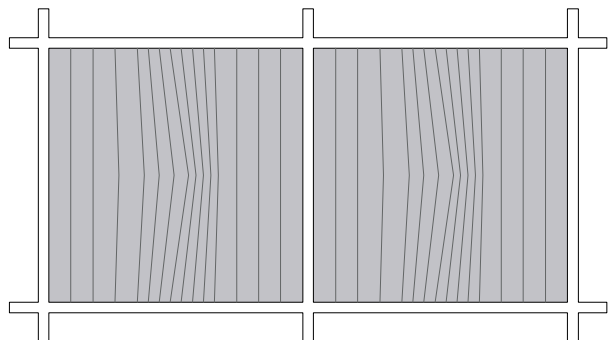

## LAYOUT EXAMPLE

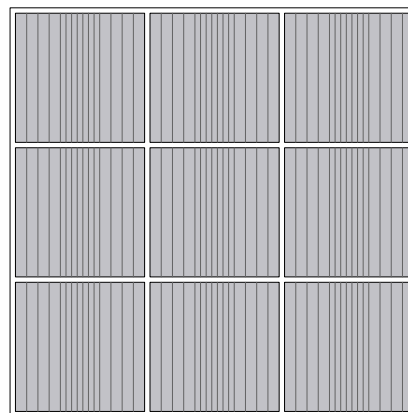
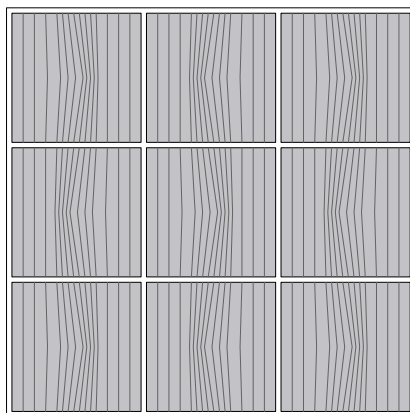

## ILLUSIO 2

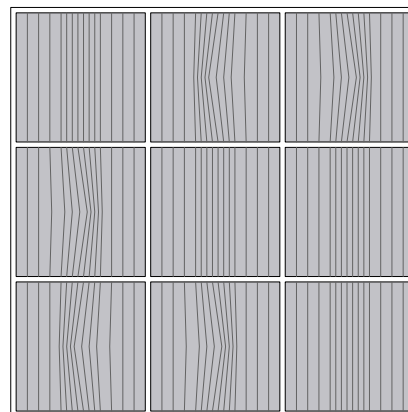
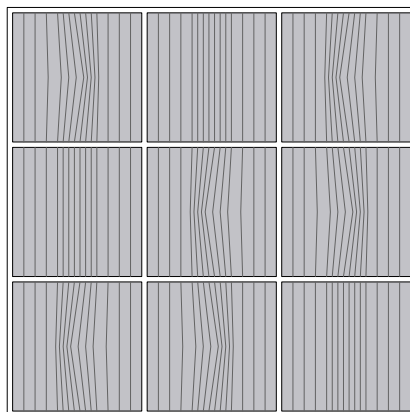
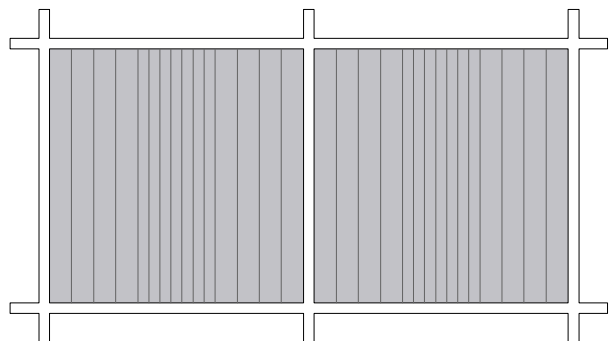

**RETE**

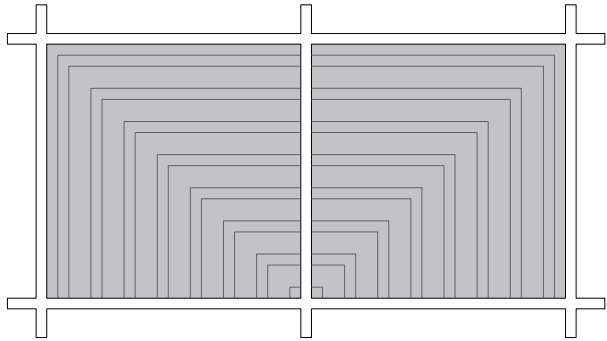

**LAYOUT EXAMPLE**

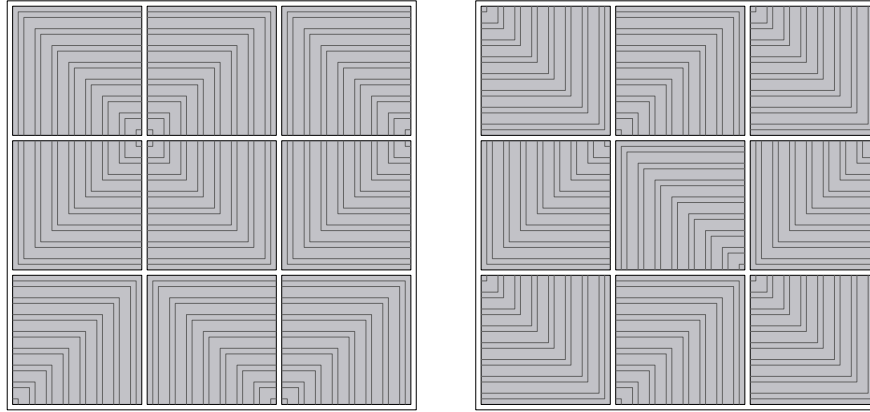

**DULCIS**

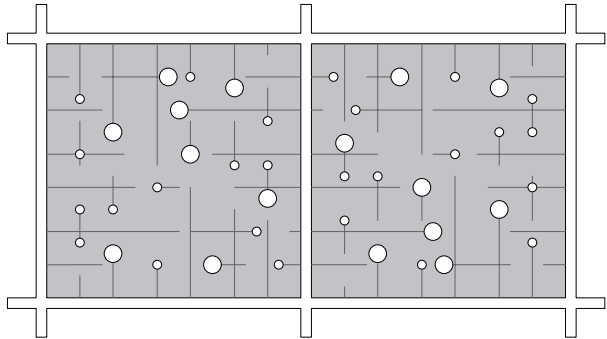

**LAYOUT EXAMPLE**

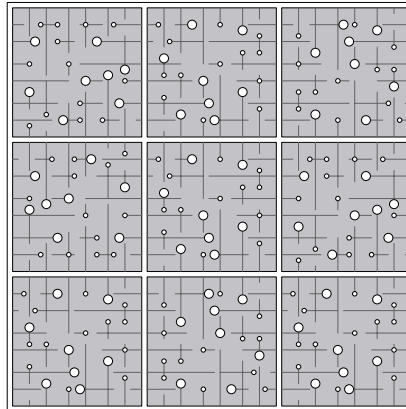



## DISPERGO

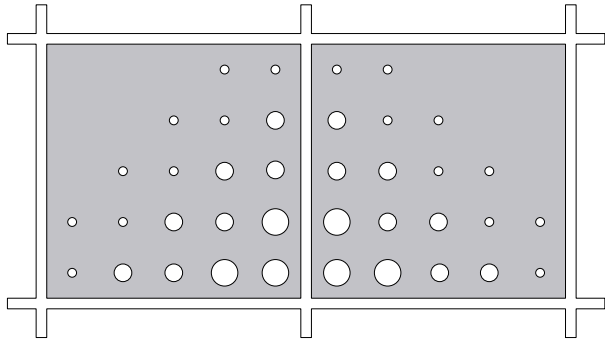

## LAYOUT EXAMPLE

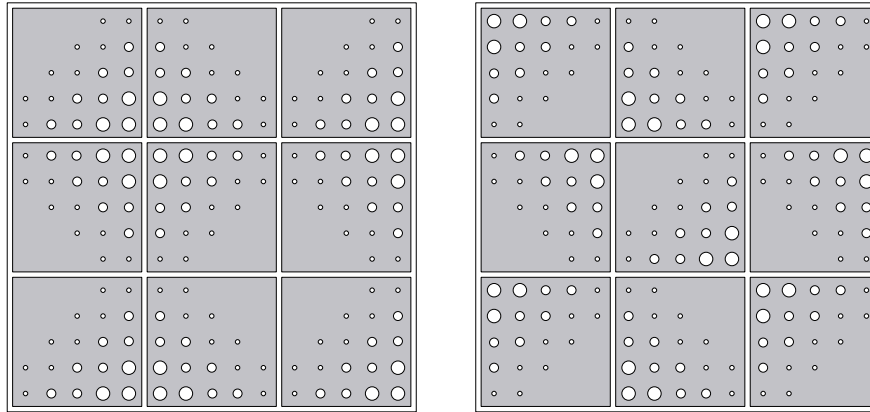

## ANGOLO 1

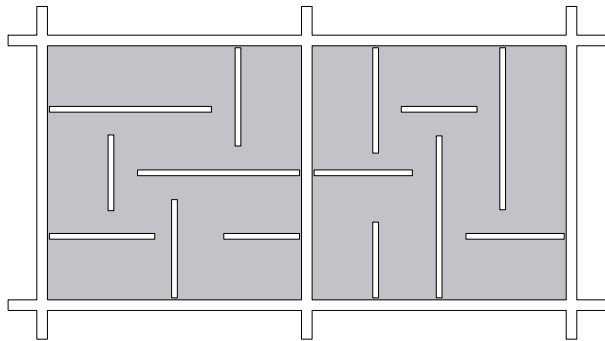

## LAYOUT EXAMPLE

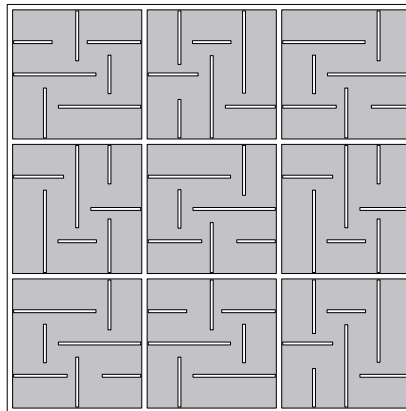

# TRANSVERSUS

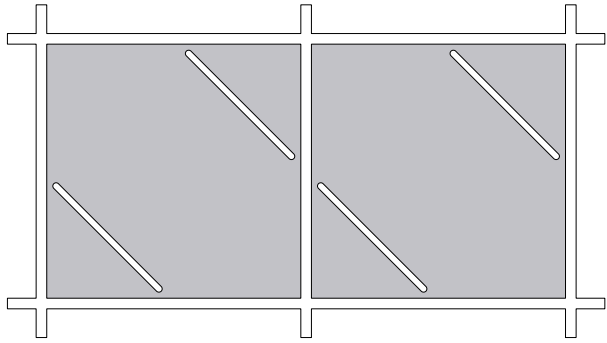

# LAYOUT EXAMPLE

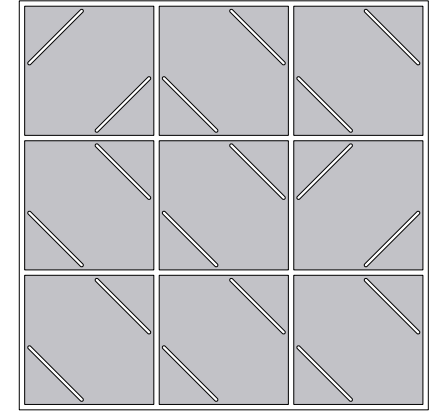
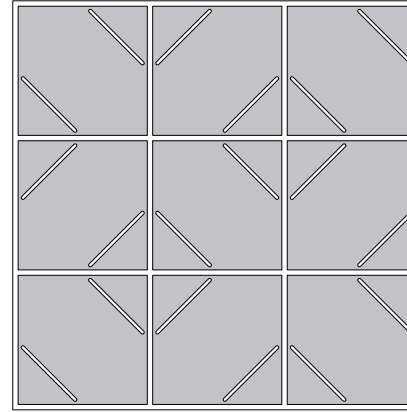
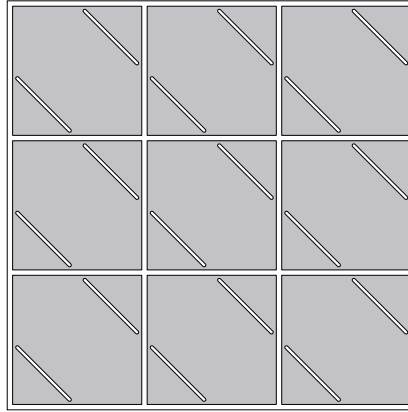

# SECARE

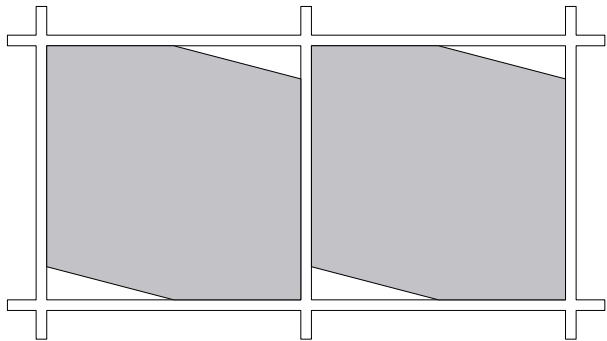

# LAYOUT EXAMPLE

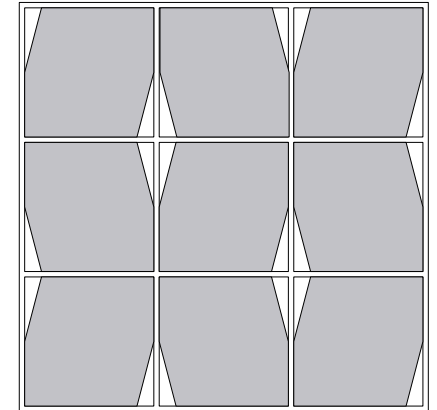
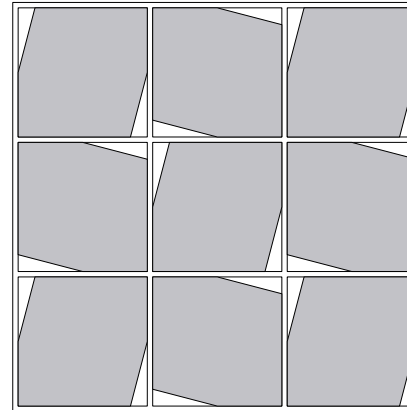
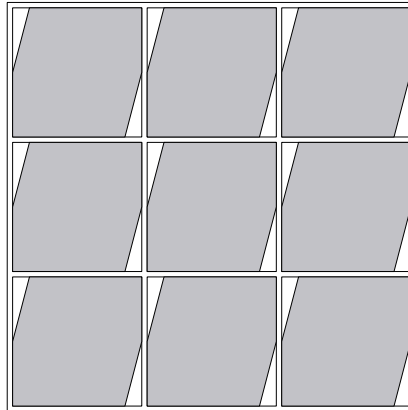

## CALEUM 1

## LAYOUT EXAMPLE

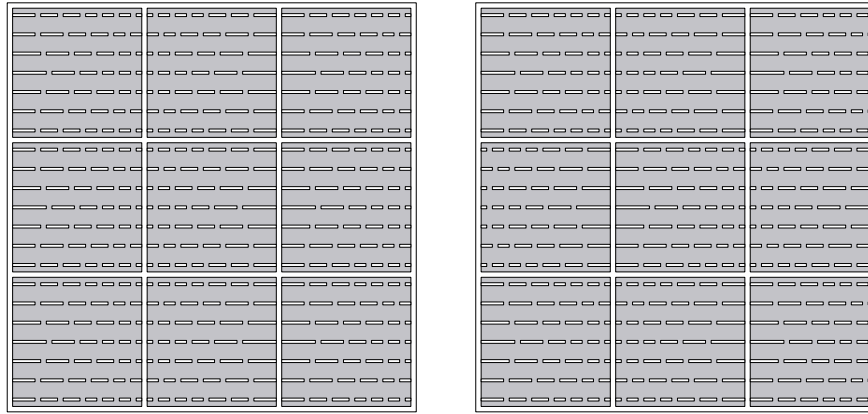
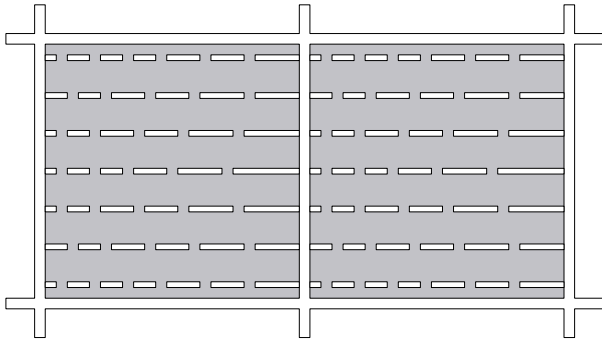

## DATASHEET PET-FELT BOARD 12 MM

- Frequency range according to the standard
- Measured characteristics

