

# Kameleon K1- Solid Back

ASSEMBLY INSTRUCTIONS

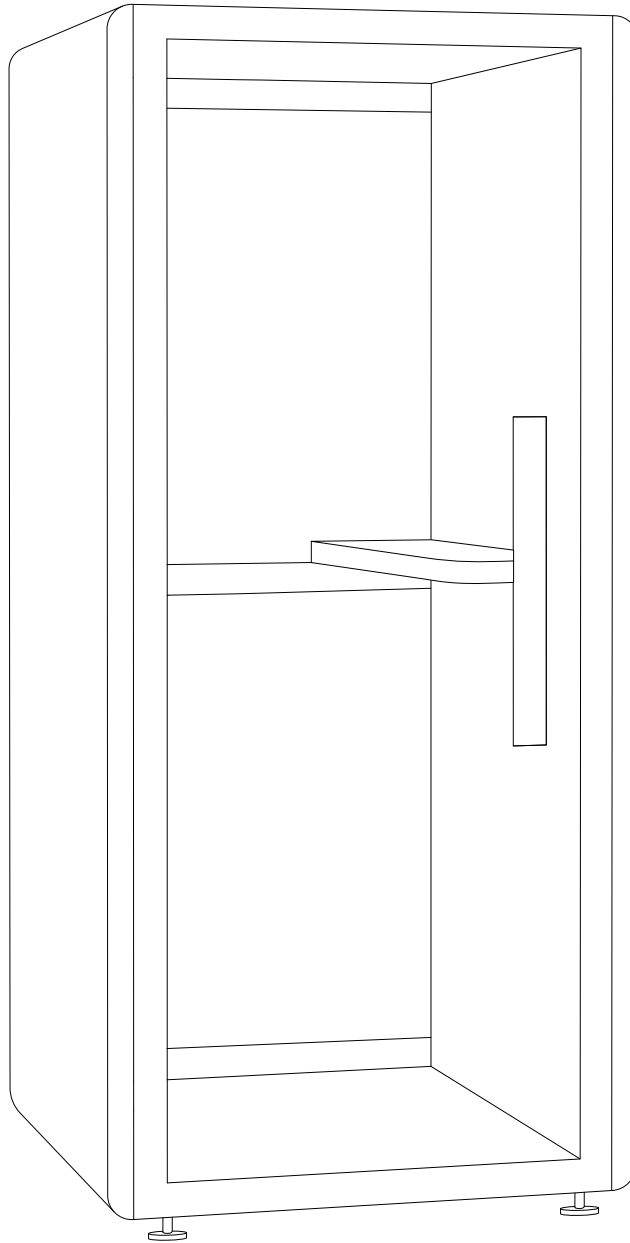

**ASKIA**  
ACOUSTIC PODS

# Info.

## ASSEMBLY INSTRUCTIONS

**1 2 3** Steps.

**A B C** Bag with screws.

 Unlocked.

 Lock.

 Level check.

 Allen key needed.

 Allen key and screws needed.

 T-Handle hex key needed.

 T-Handle hex key and screws needed.

 Position the door on pins.

 Screwdriver needed.

 Power drill needed.

 Move in place.

 Whiteboard.

 Pinboard.

 VESA Adapter.

 Main Ethernet supply.

 Main Power supply.

 Ventilation coupling.

 Power coupling.

 Ethernet coupling.

 Lighting coupling.

 Motion sensor coupling.

 Magnetic coupling element.

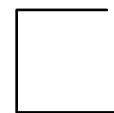
 Pay attention to.

 Pay attention to.

 Do.

 Don't.

 Pay attention not to break the glass.

 Ok.

 Stop.

---

# Assembly in 40 min. with 2 people

---

## Included

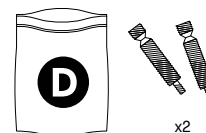
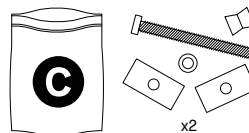
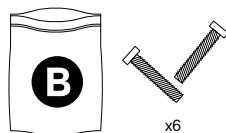
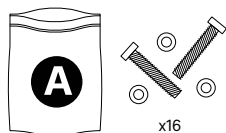
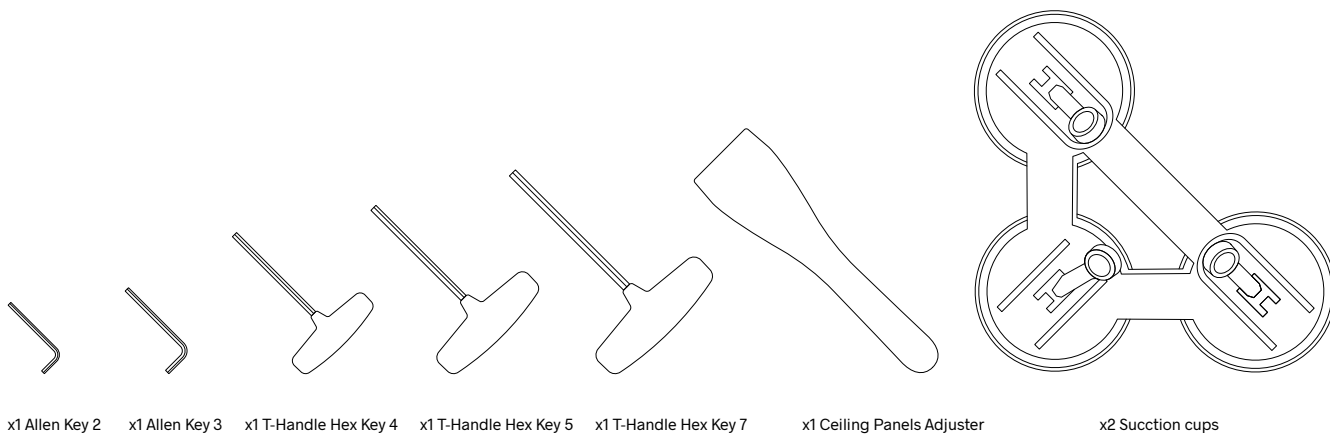

---

## Not Included

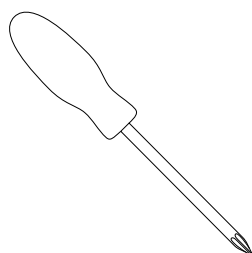

Screwdriver

---

# Elements

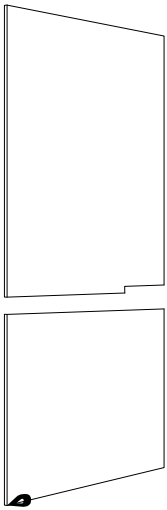

x2 Middle Back Panels

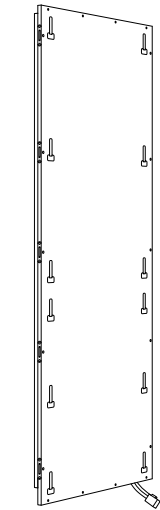

x1 Middle Structure Panel

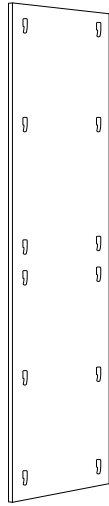

x1 Exterior Back Panel

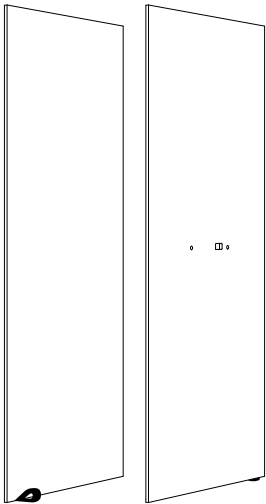

x1 Left & x1 Right Interior Panel

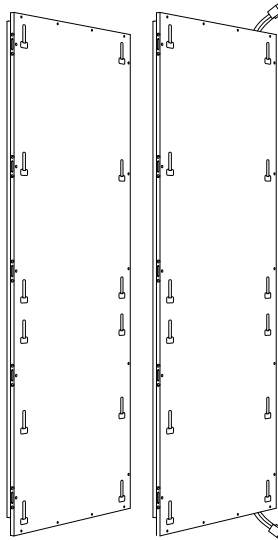

x1 Left & x1 Right Structure Panels

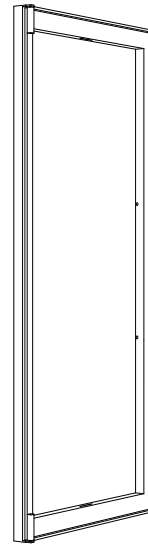

x1 Door Frame

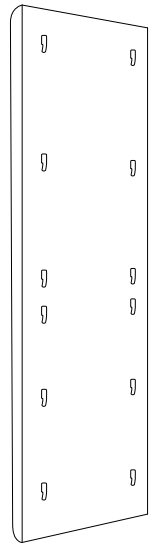

x2 Exterior Panel

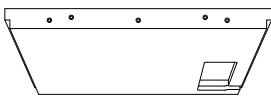

x1 Ceiling



x3 Acoustic Felt Ceiling Panels

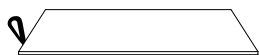

x1 Carpet

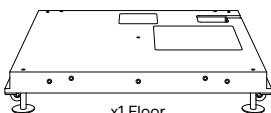

x1 Floor



x1 Door Handle



x1 Table

1

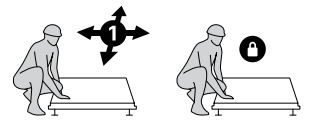
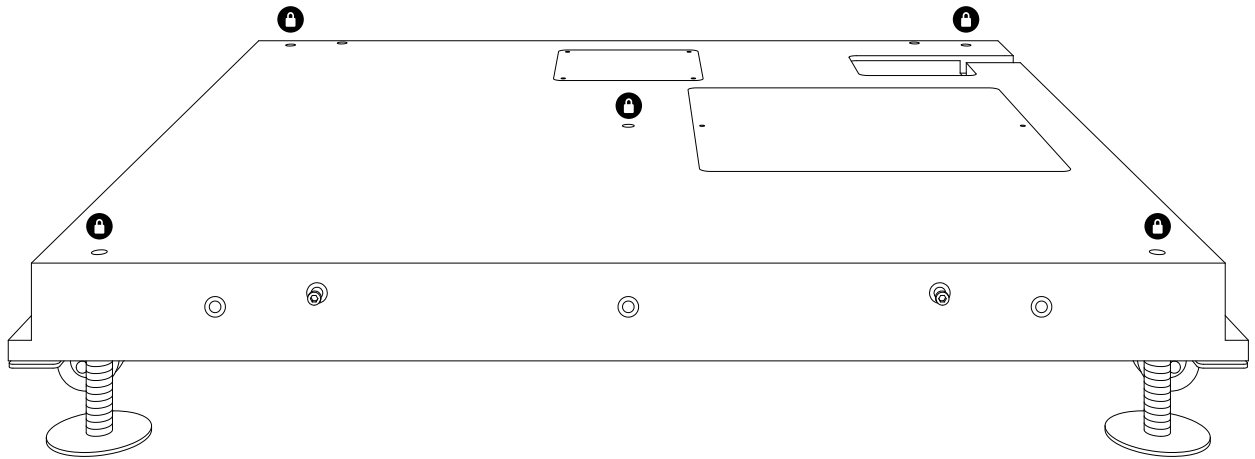

T-Handle Hex Key 4

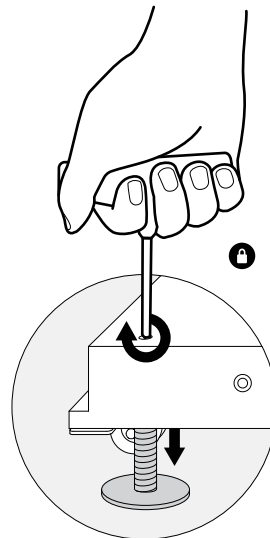
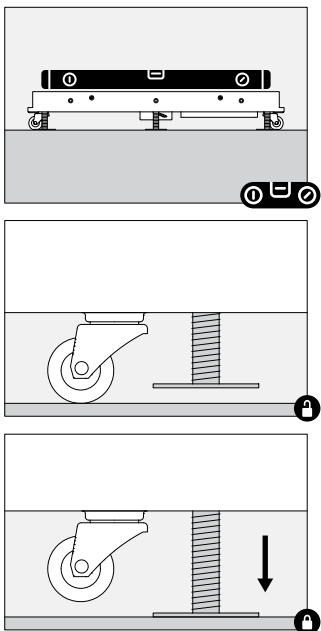

# 2

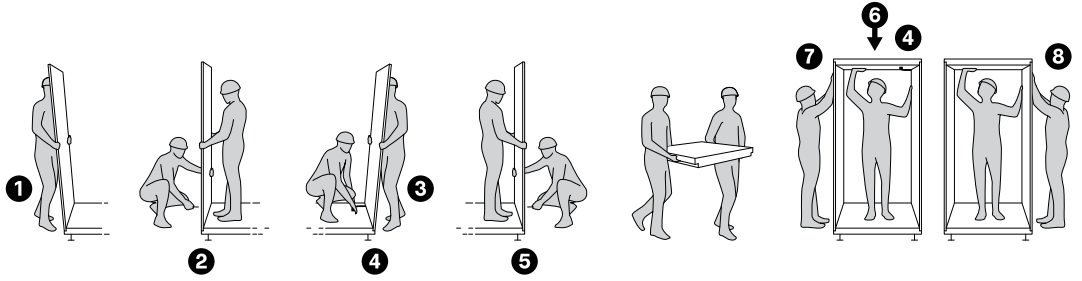
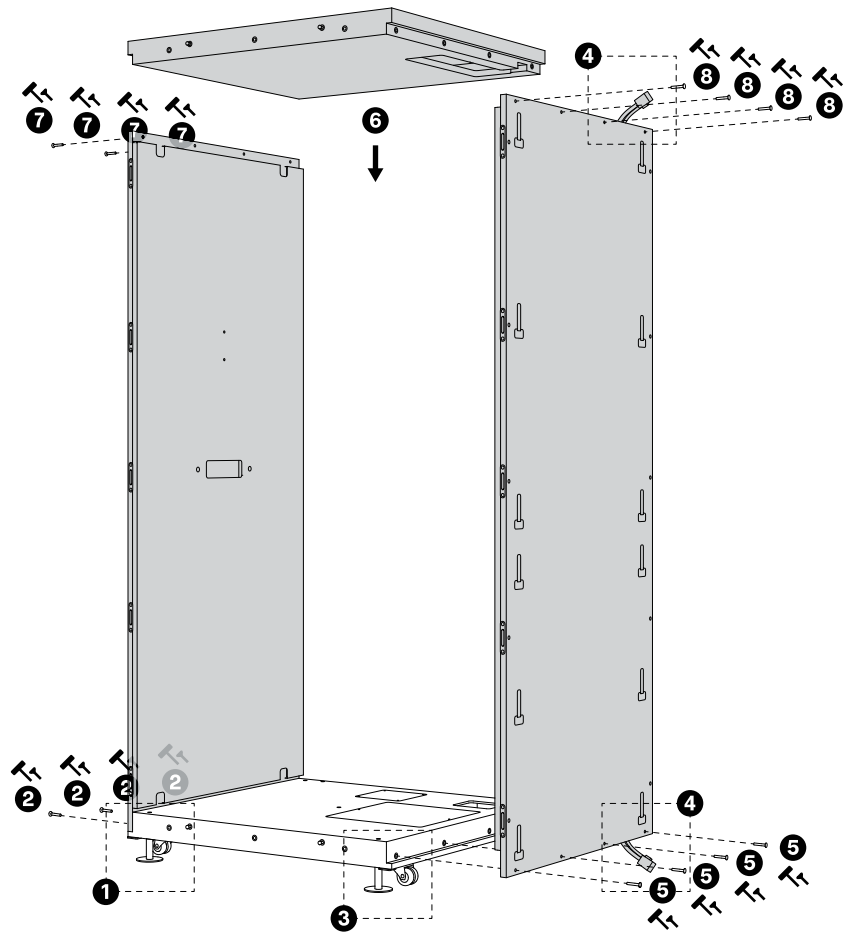

**A** x16 with  
T-Handle Hex Key 4

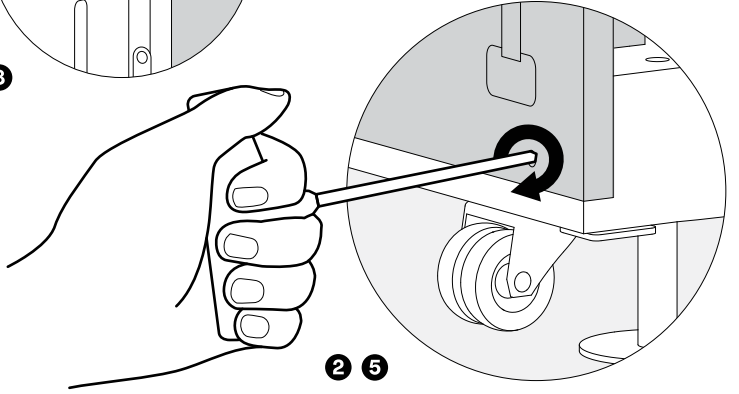
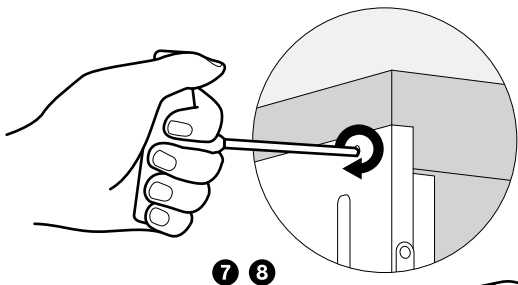
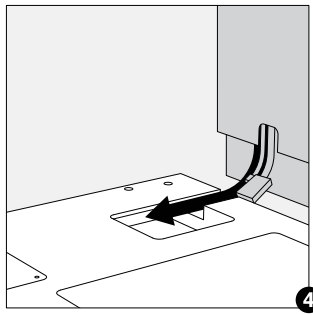
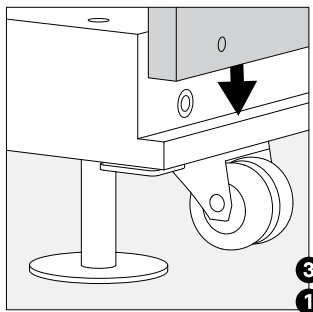

# 3

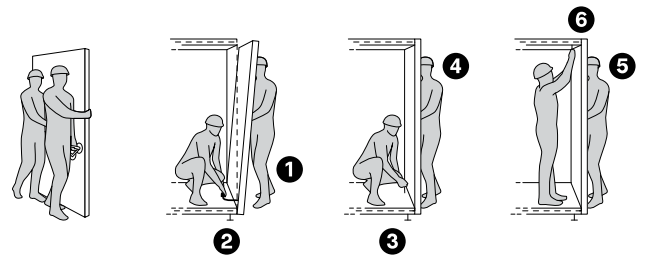
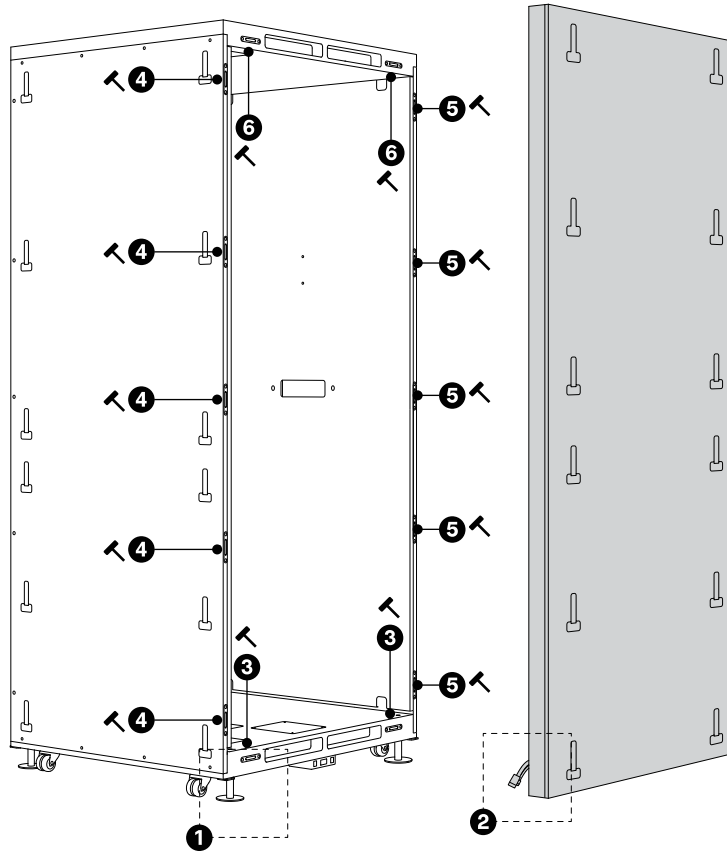

**T-Handle Hex Key 7**  
**Suction cup handles**

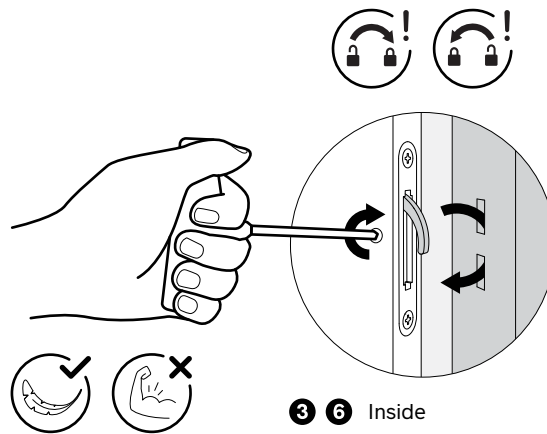
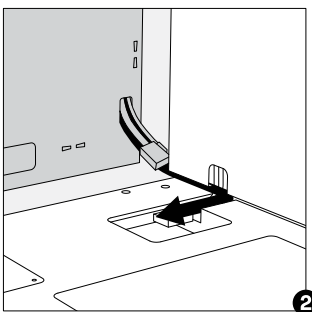
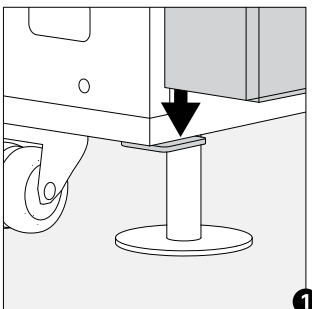

**3 6** Inside  
**4 5** Outside

# 4

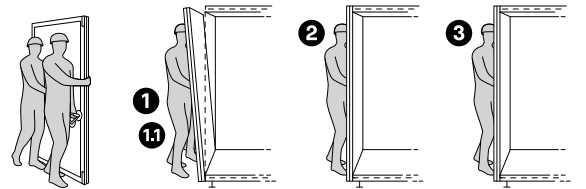
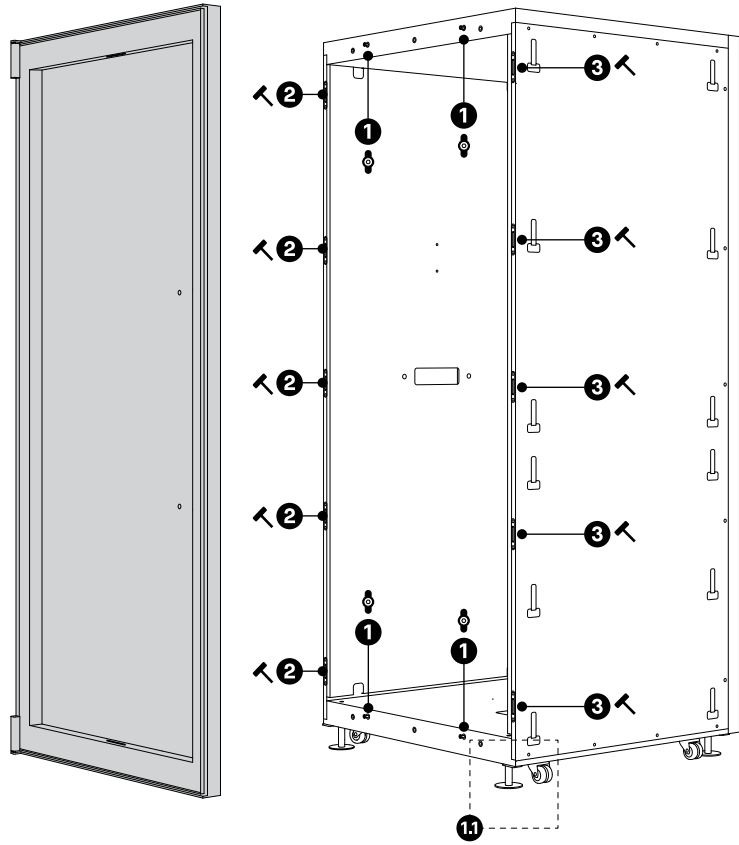

**T-Handle Hex Key 7  
Suction cup handles**

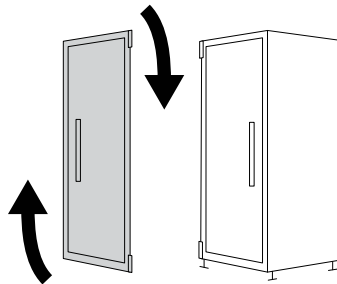
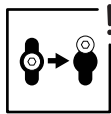
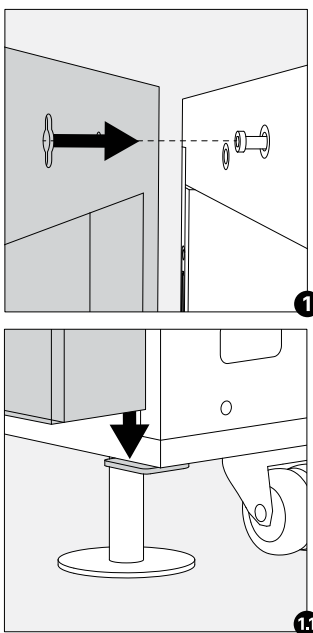

The door opening can be oriented **Left** or **Right** just by rotating the frame.

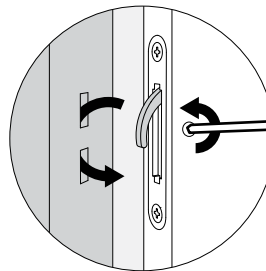

**2 3** Outside





# 5

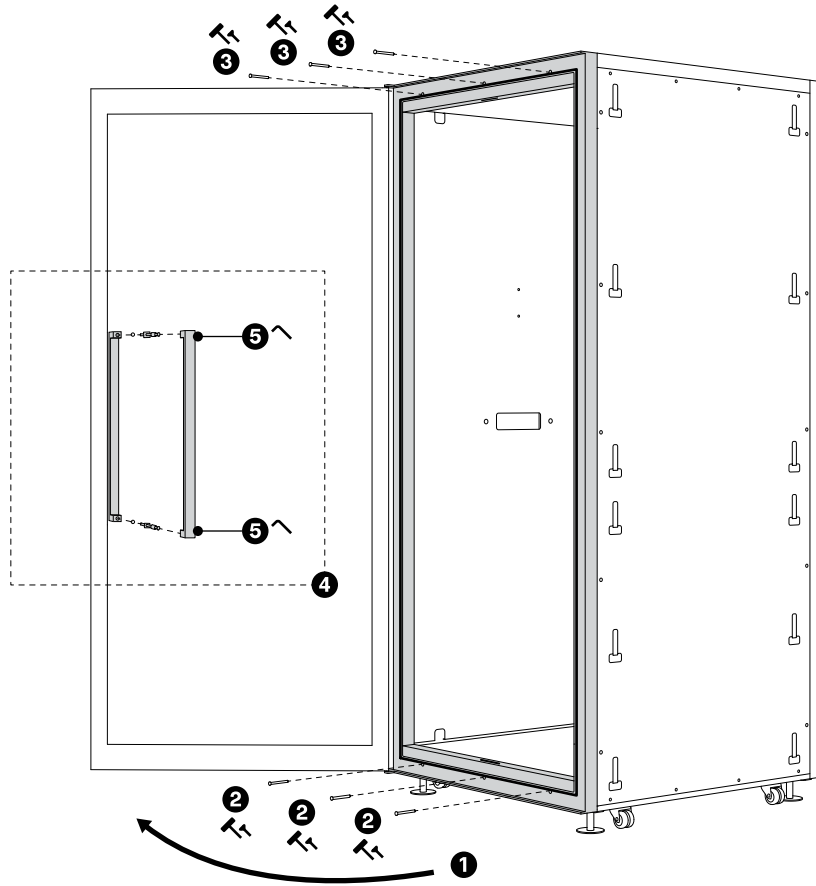

**B** x6 with  
T-Handle Hex Key 4

**C** x2 with  
Allen Key 3

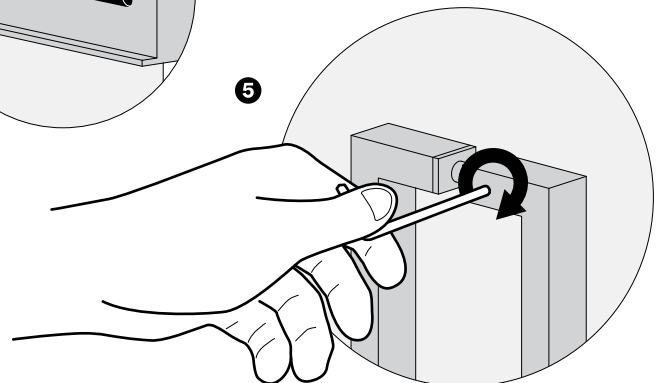
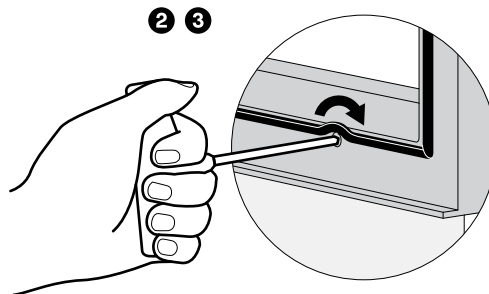
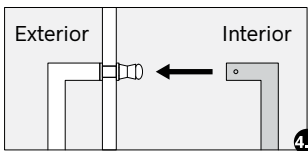
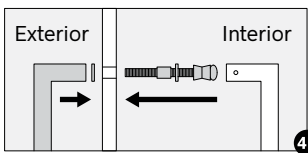
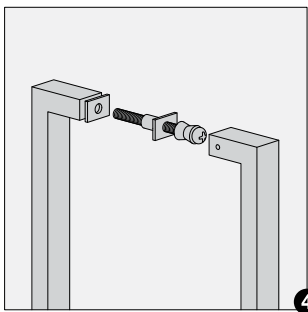
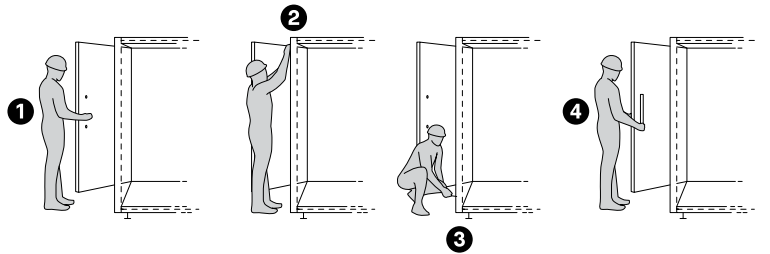

# 6

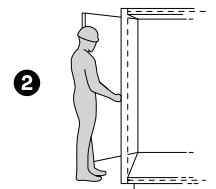
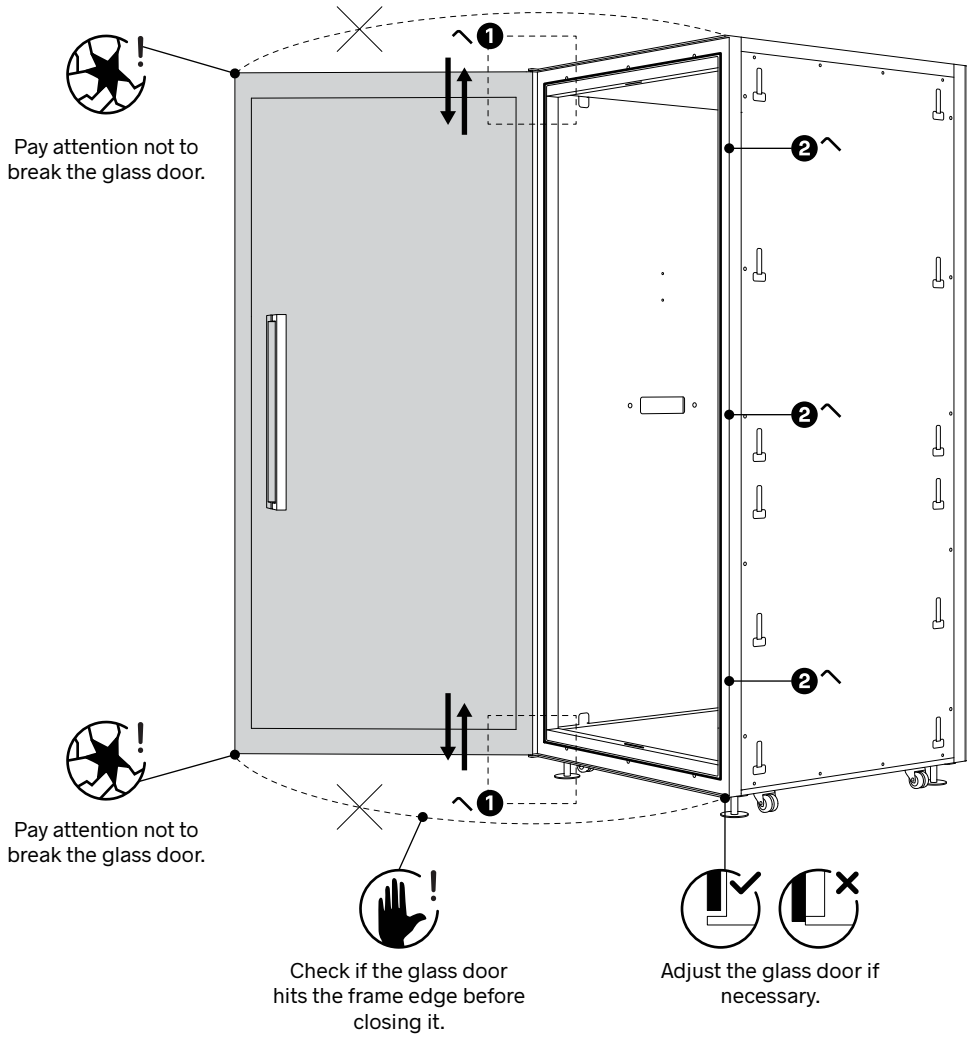

Allen Key 3  
Allen Key 2

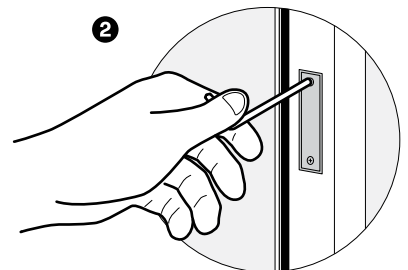
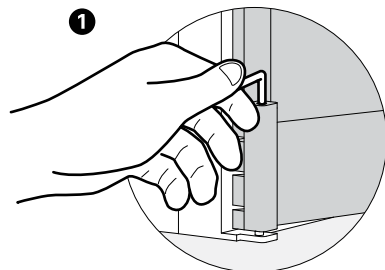
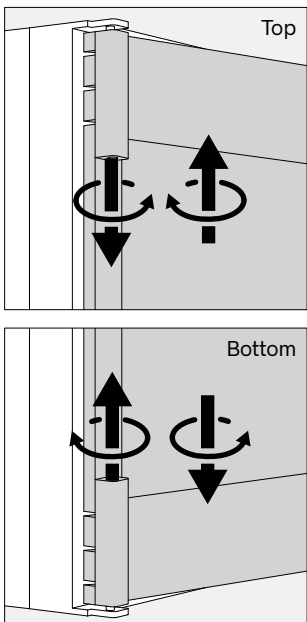

To adjust the glass door the height must be calibrated. If you need to raise the glass door, you loosen the top hinge and tighten the bottom hinge.

If you need to lower the glass door, you loosen the bottom hinge and tighten the top hinge.



Check if the door closes properly and adjust the door plates if needed.



Tighten or loosen the plates when needed.

# 7

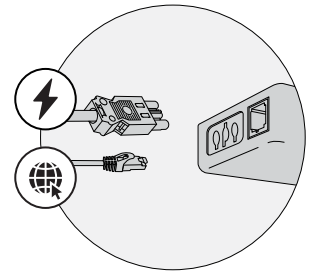
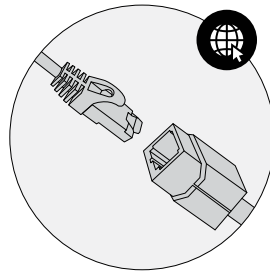
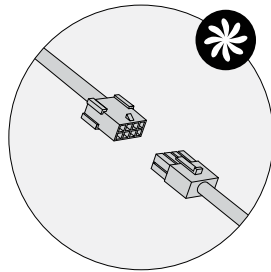
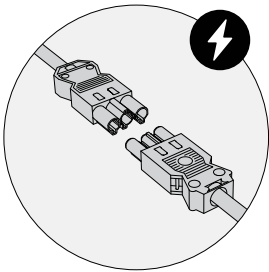
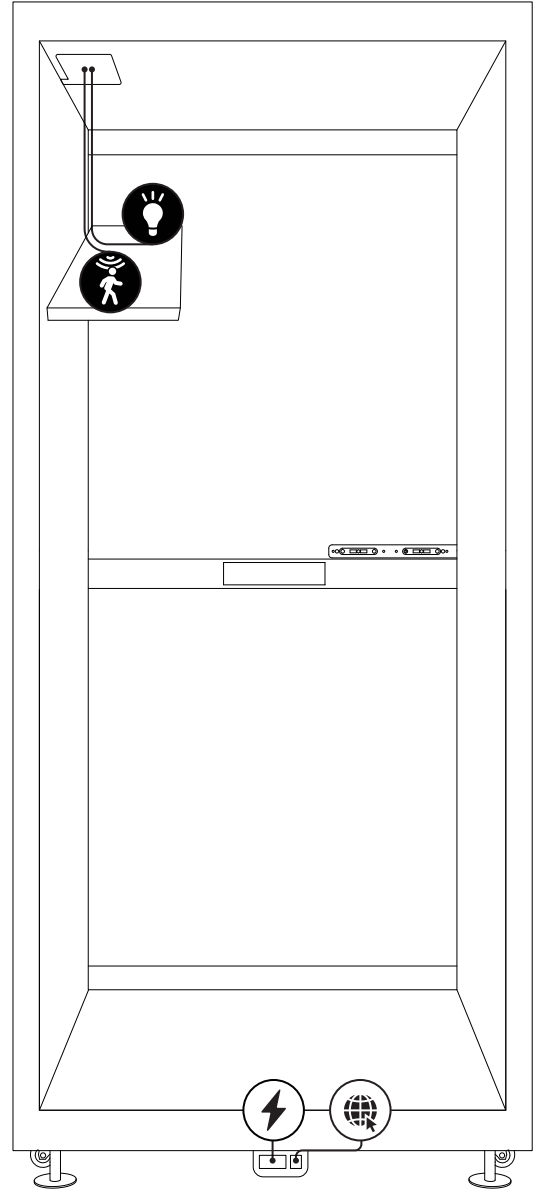
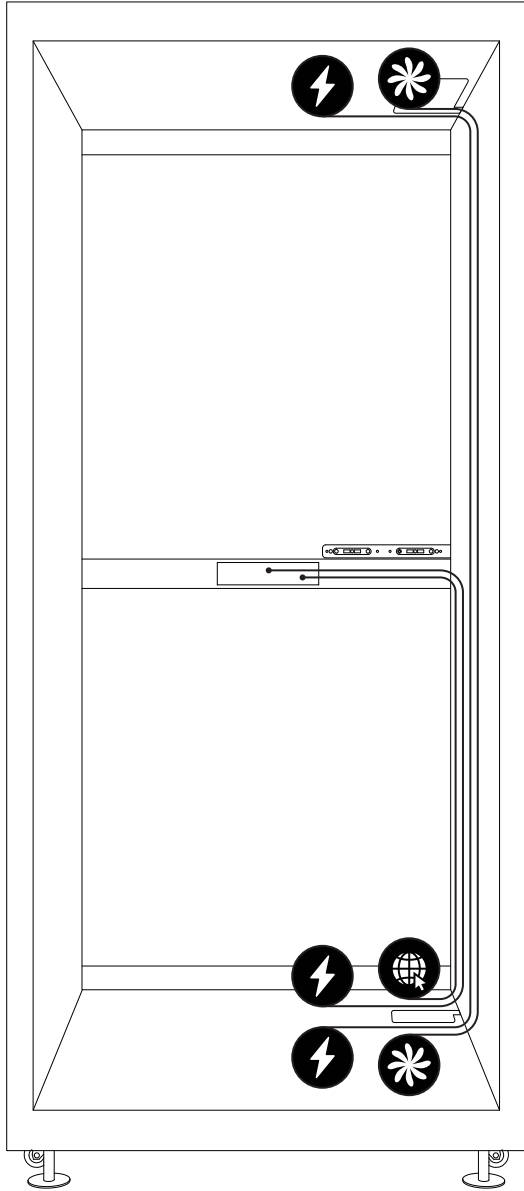

Orange

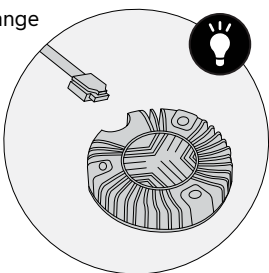

Black

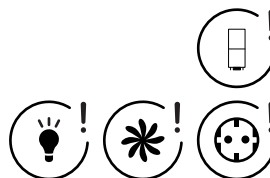
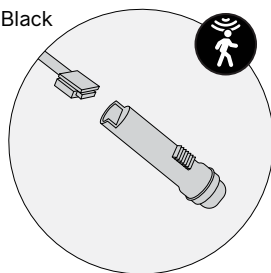

! Main Power & Ethernet supply at the back of the pod.

! Check if the lighting, ventilation and power sockets are connected properly.

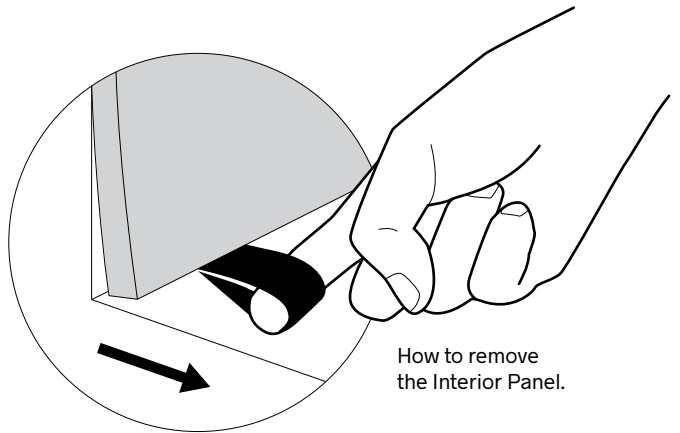
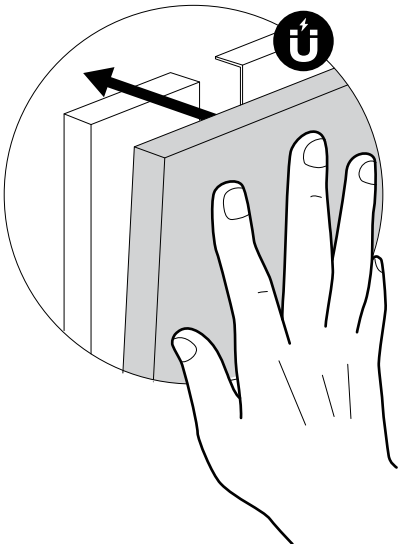
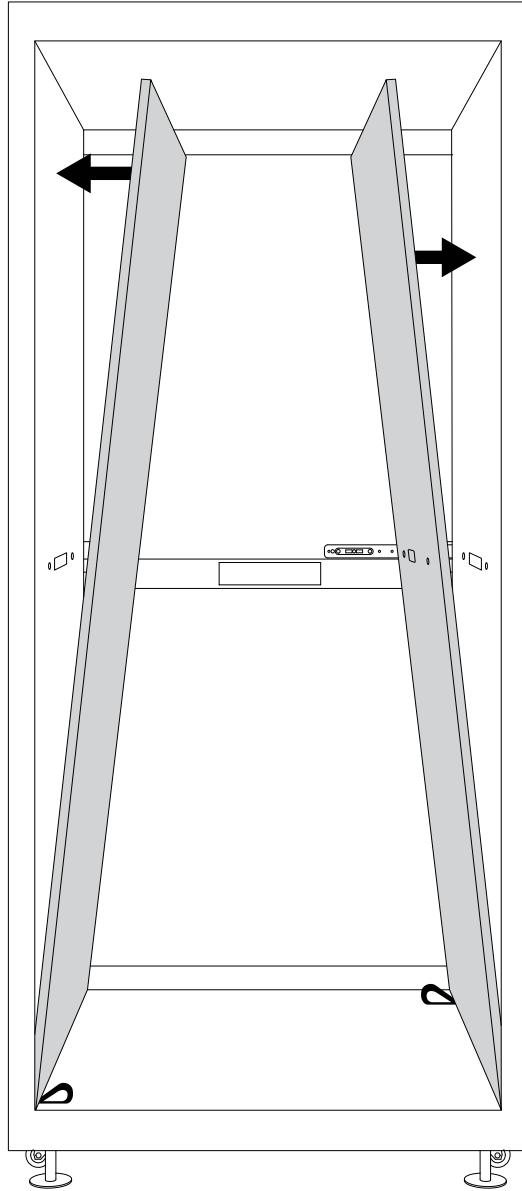

How to remove the Interior Panel.

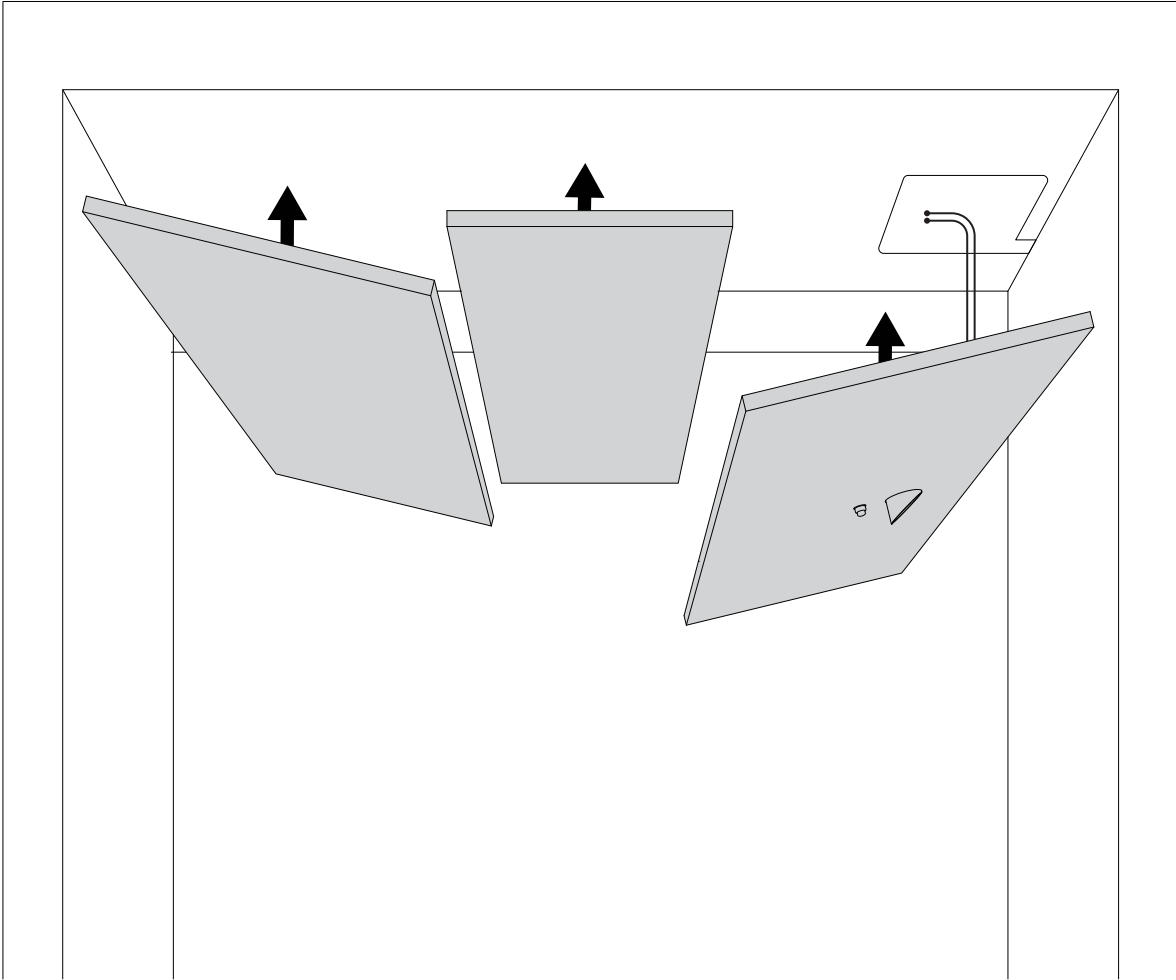

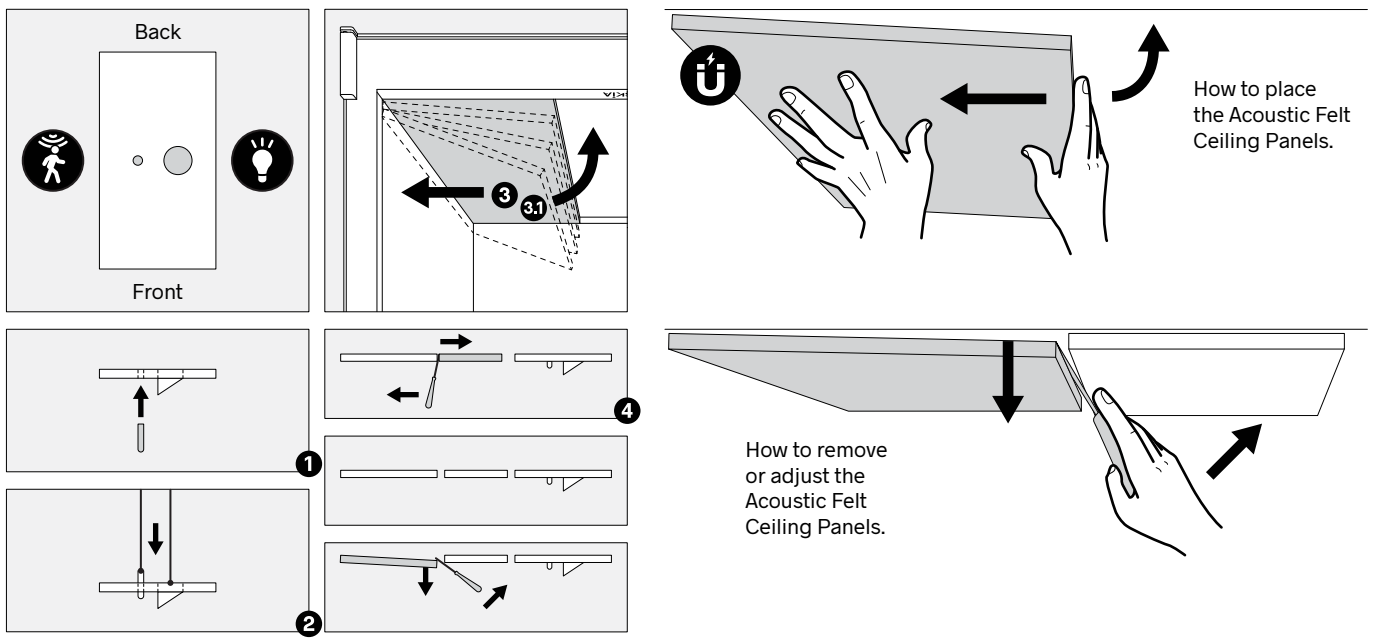

**Ceiling Panels Adjuster**

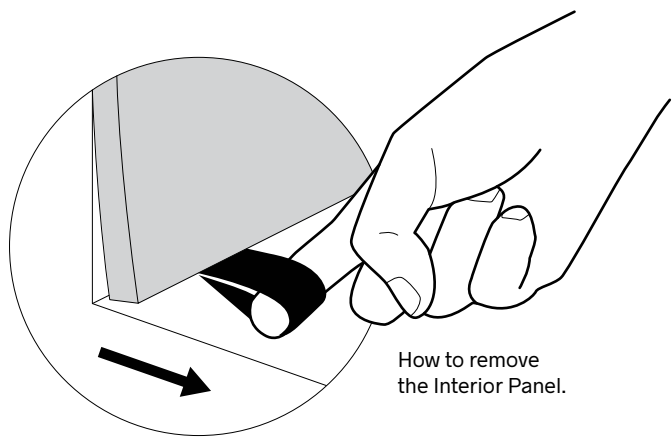
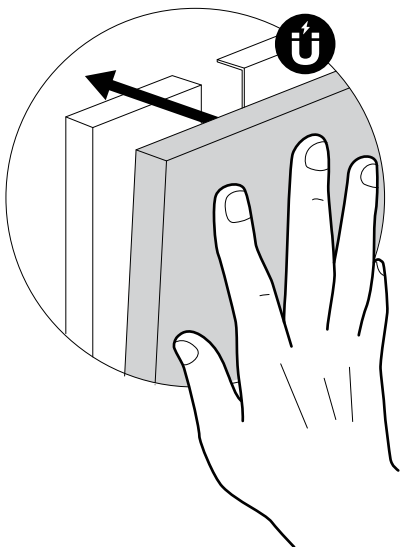
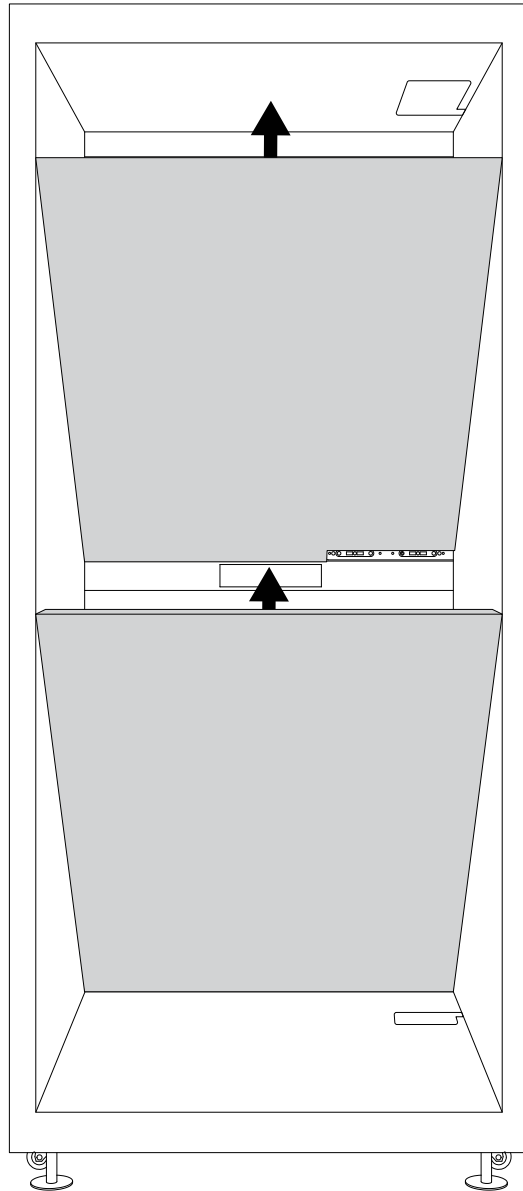

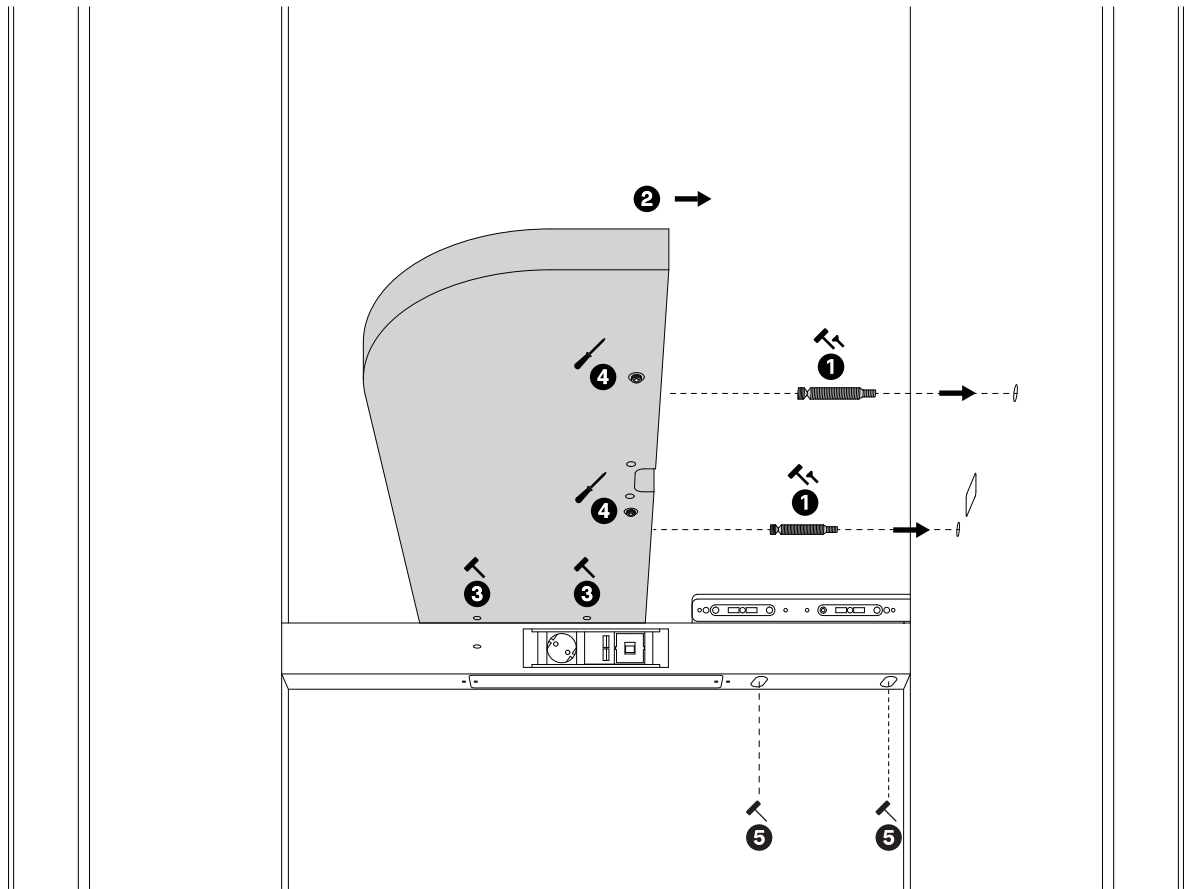

How to remove the Interior Panel.



 x2 with  
**T-Handle Hex Key 5**

**T-Handle Hex Key 7**  
**Screwdriver (Not Included)**

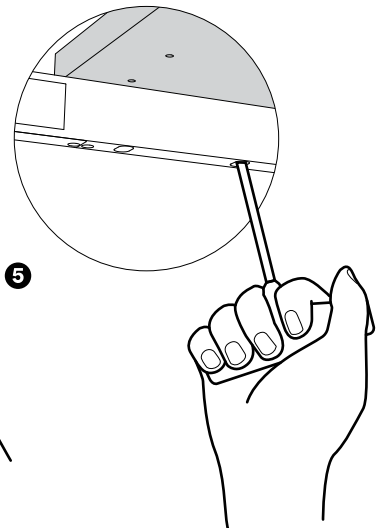
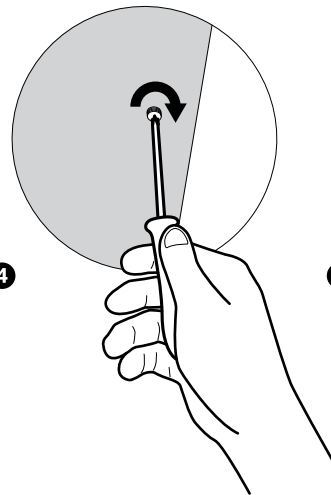
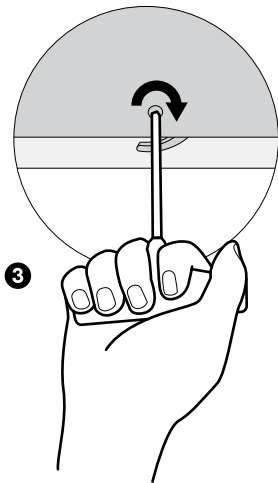
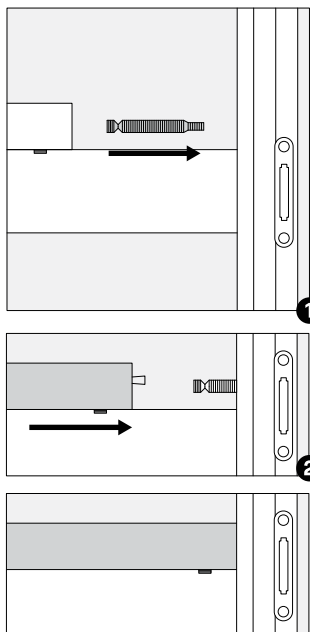

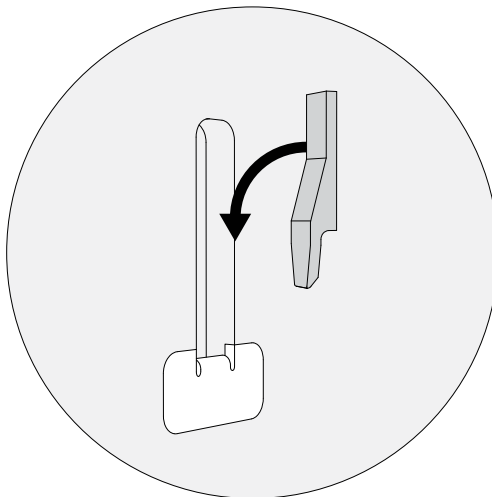
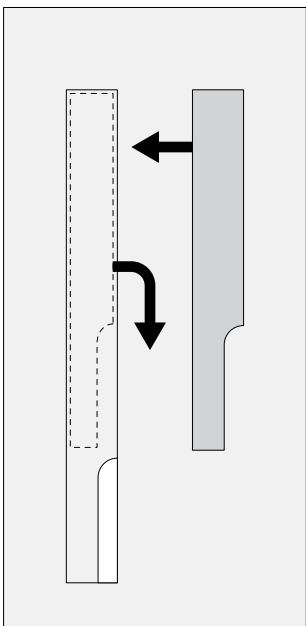
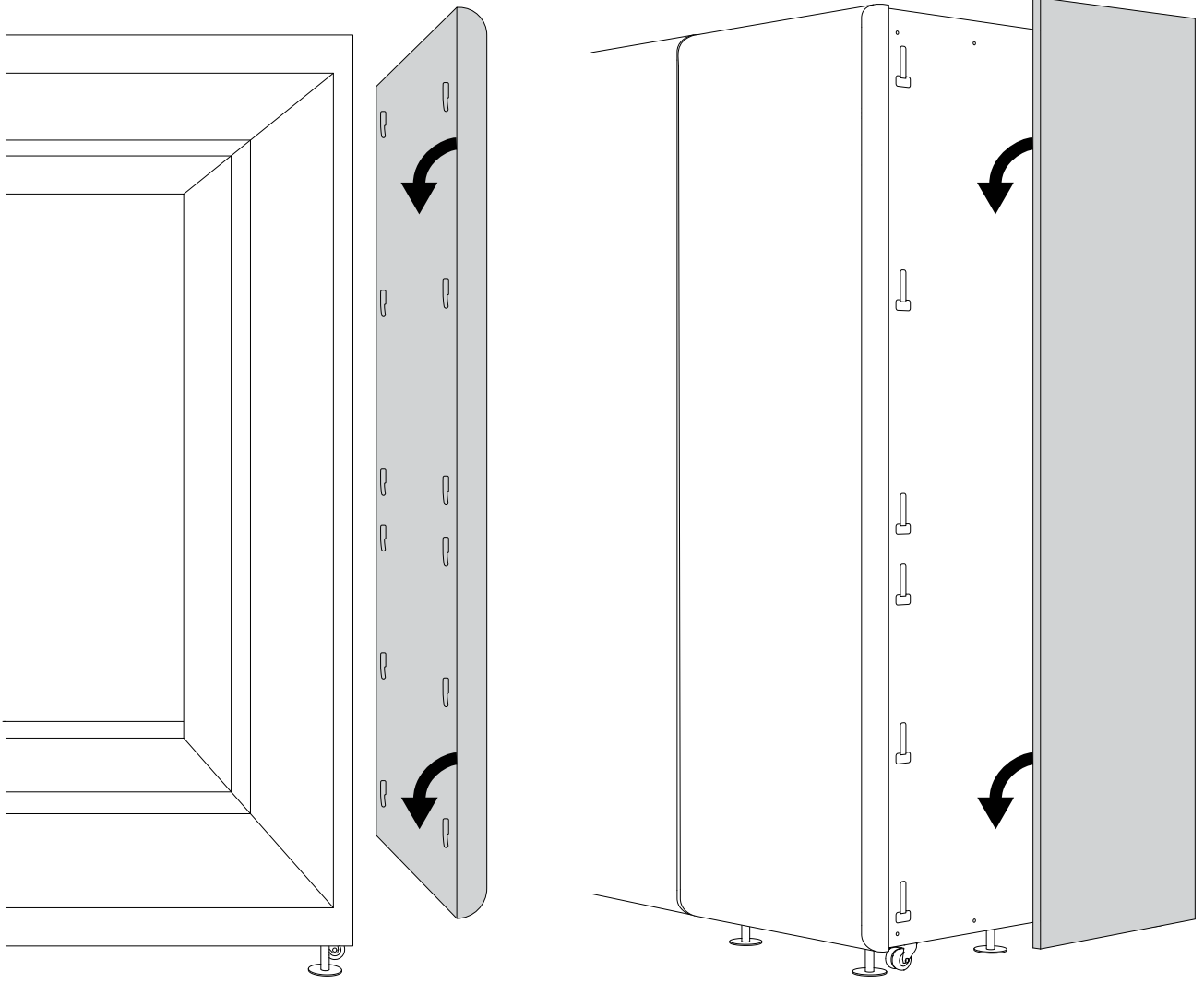



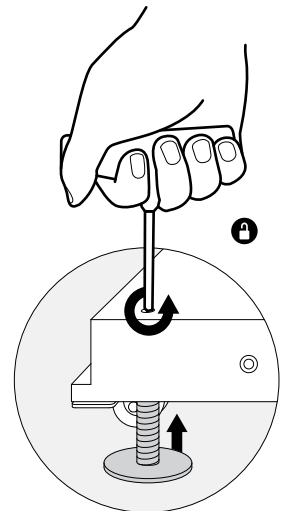
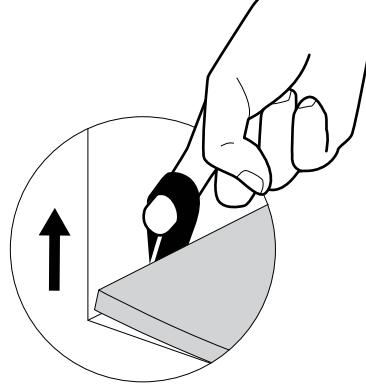
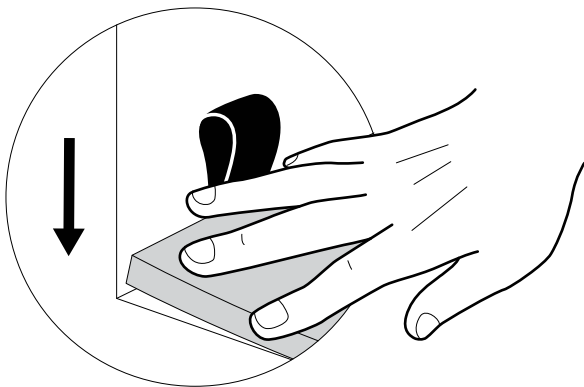
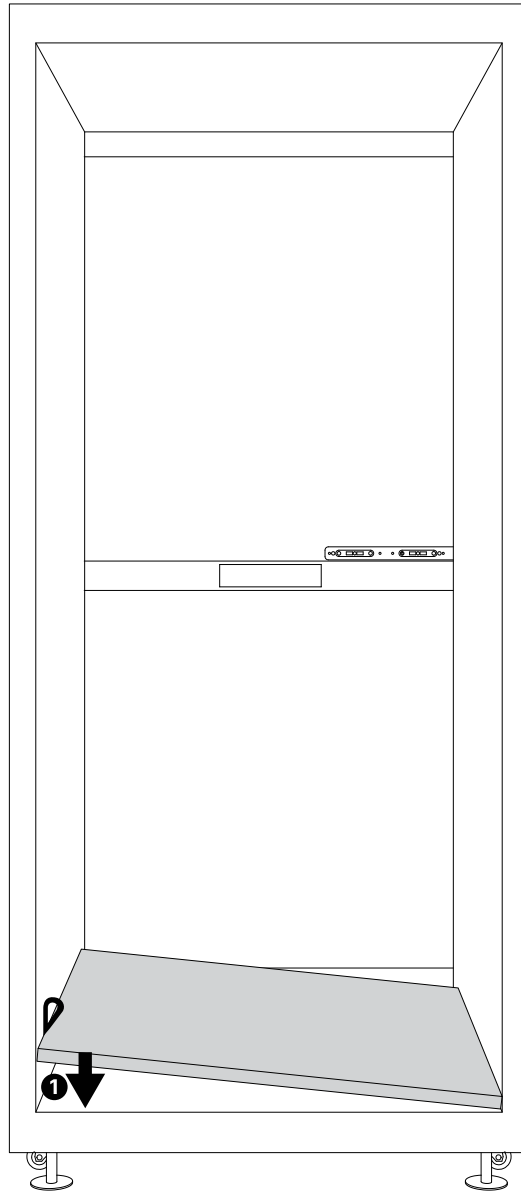

If you are satisfied with the pod's position, you can place the carpets.



If you want to reposition the pod, you have to remove the carpet, if needed, and unlock the legs. When you are satisfied with the pod's position, lock the legs and place the carpets.

# Adjustable FAN and LED

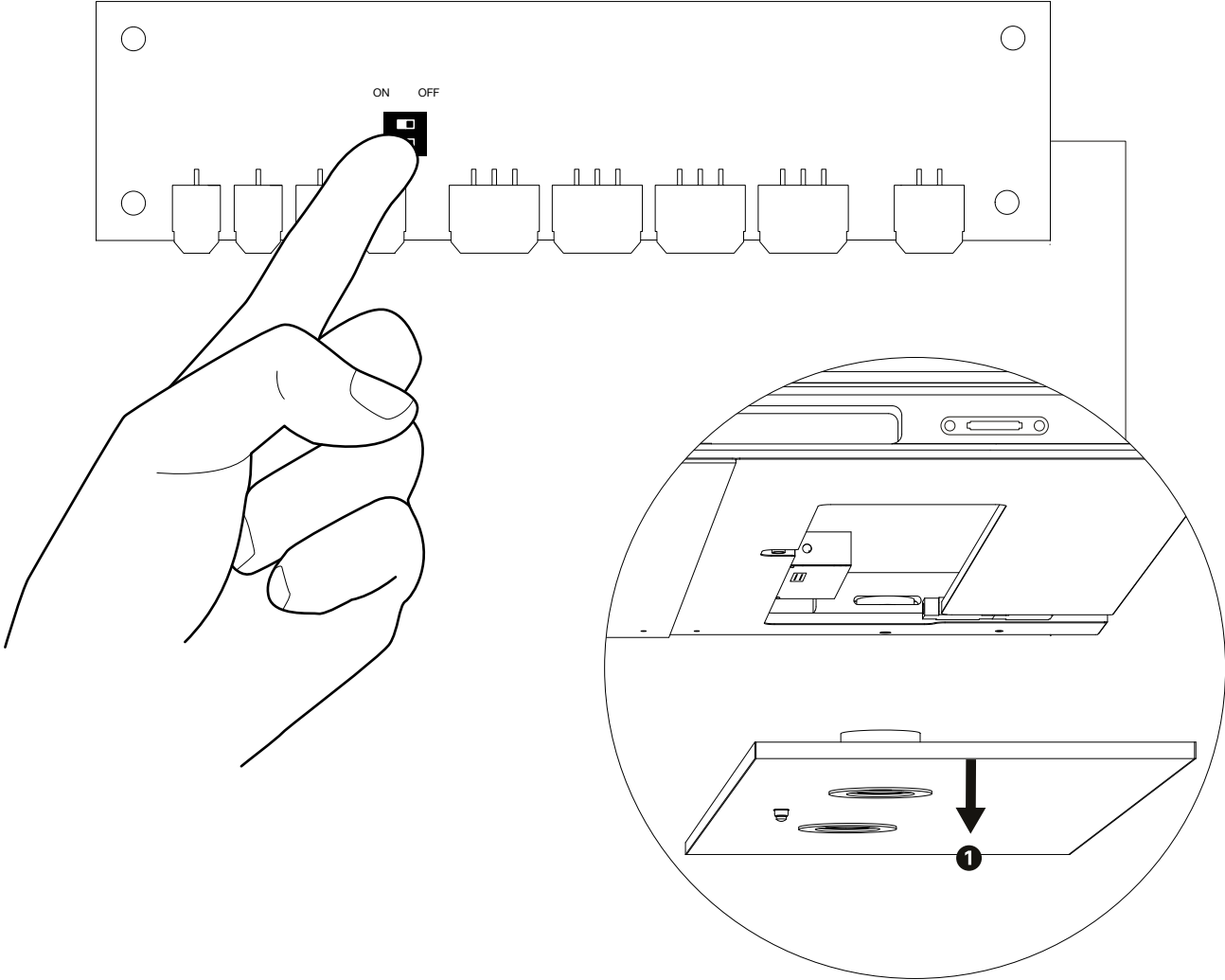

## FAN

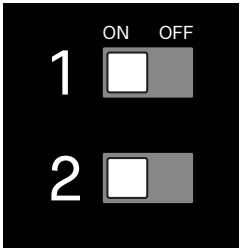

100%

OFF

OFF

80%

OFF

ON

60%

ON

ON

# Scan

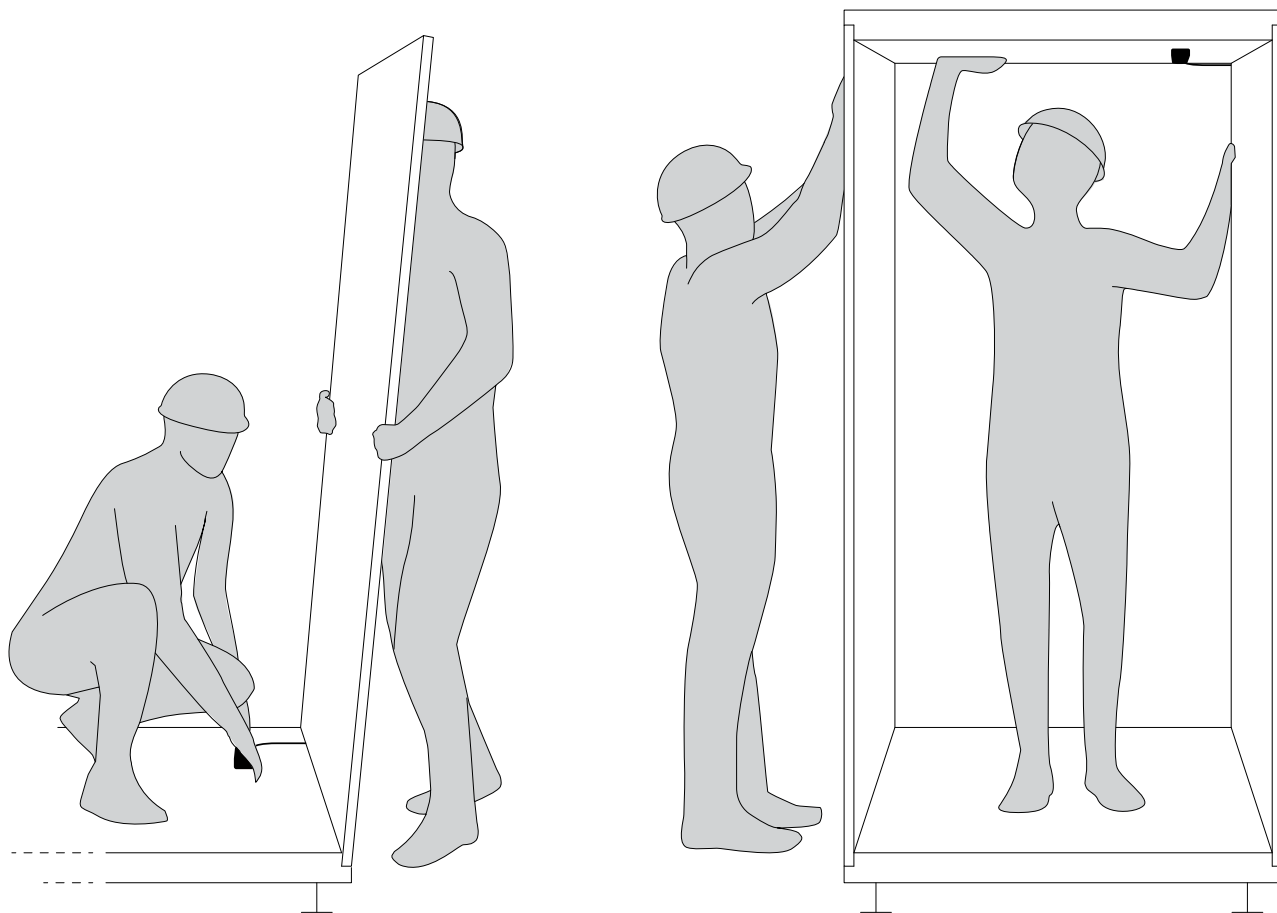

You can watch an instructional video of the K1 assembly process. Thanks to the modular design and limited number of components used for each pod, many steps are similar between different Kameleon pods.



# Optional



VESA Adapter

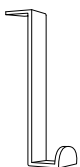

Coat Hanger

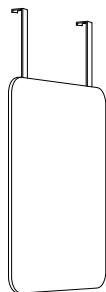

Exterior Hanging  
Whiteboard or Pinboard

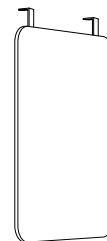

Interior Hanging  
Whiteboard or Pinboard



There are multiple features that you can personalize your pod with. You can view them for each Kameleon on our website [www.askiafurniture.ro](http://www.askiafurniture.ro)

**ASKIA**

Eliade Tower,  
Mircea Eliade No.18  
RO-Bucharest, 012015

T +40 212 121 381  
[contact@askiafurniture.ro](mailto:contact@askiafurniture.ro)

**[www.askiafurniture.ro](http://www.askiafurniture.ro)**  
Last update: 06.02.2023