

CONNECT Collection - FIX SCREEN

ASSEMBLY INSTRUCTIONS

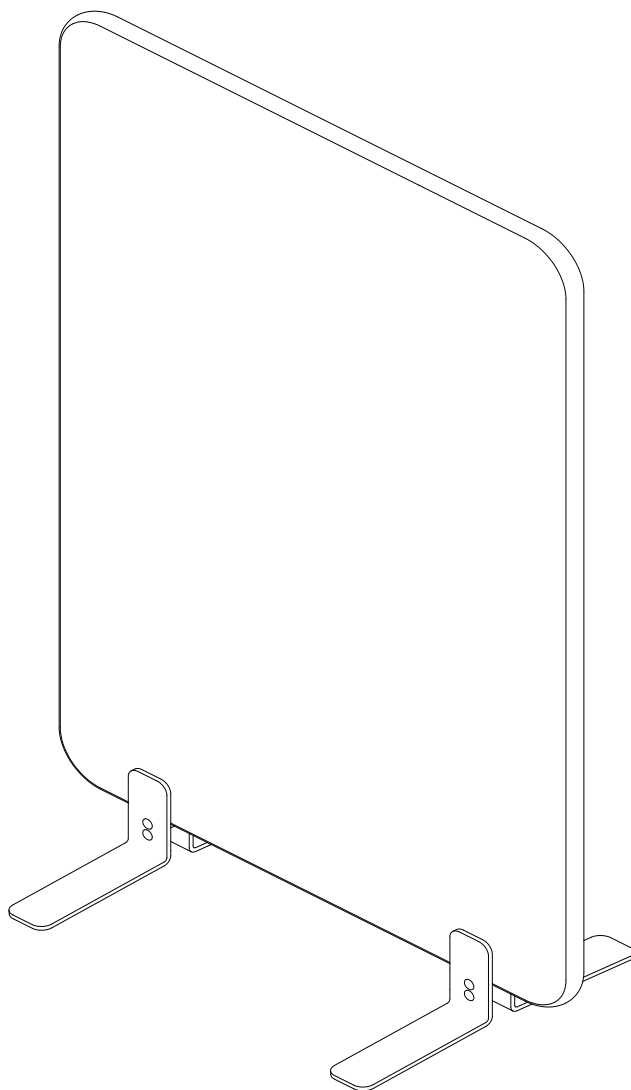

ASKIA

Info

1 2 3 Steps.

^ Allen key needed.

Included

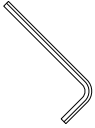

x1 Allen Key 4

Elements

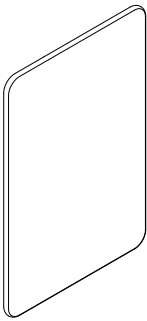

Screen

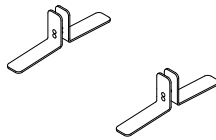

Static Base

1

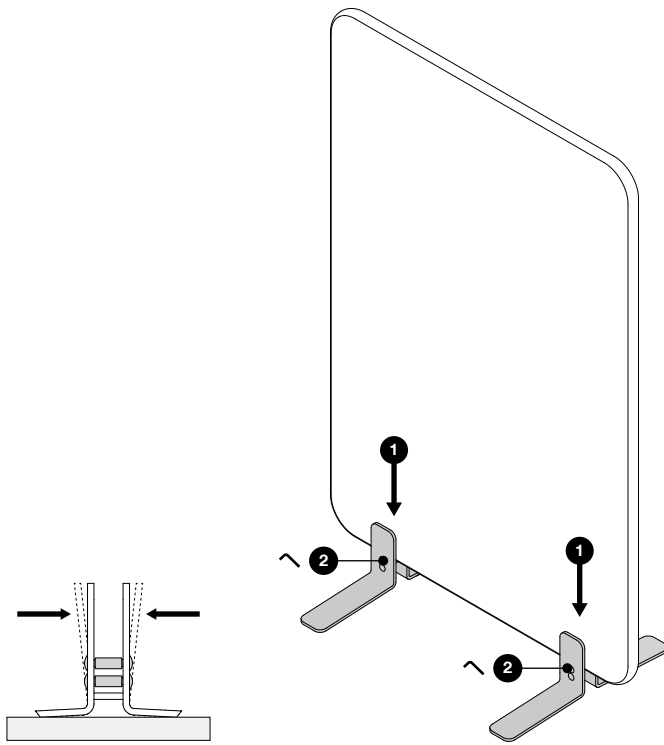

Bottom screw should be slightly loose

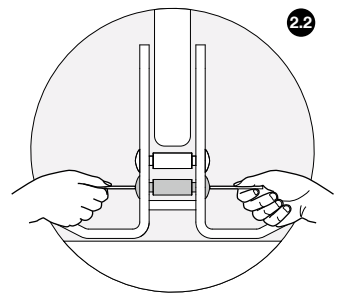
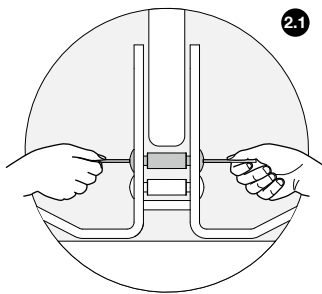
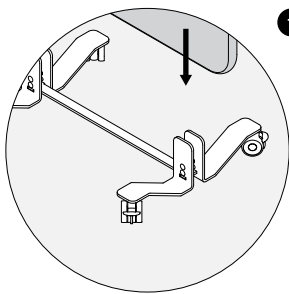

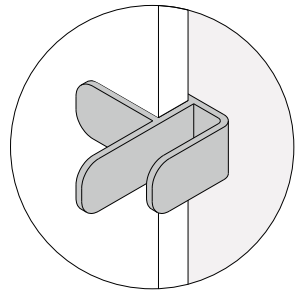
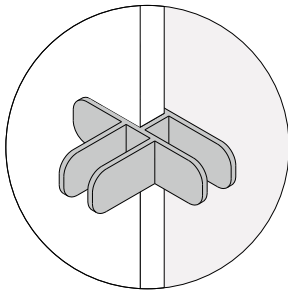
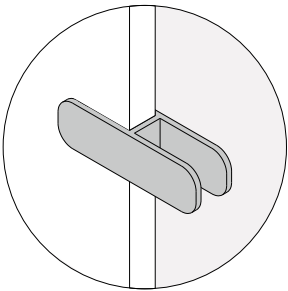
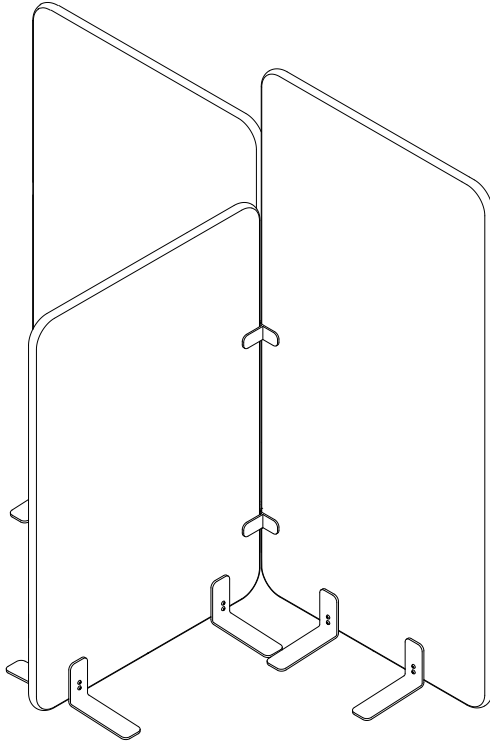

Optional

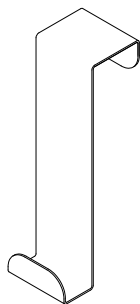

coat hanger

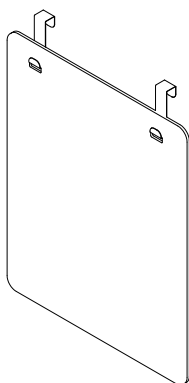

2 in 1
Pinboard/White board

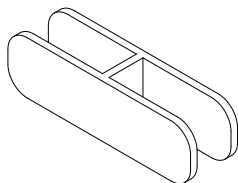

Connector H

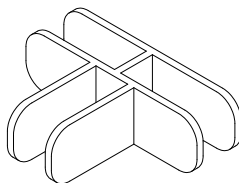

Connector T

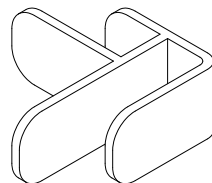

Connector L



There are multiple accessories that you can attach to your screen. Find out more on our website www.askiafurniture.ro



You can watch an instructional video of the Connect screens assembly process. Thanks to the modular design and limited numbers of components used for each screen, many steps are similar between different Connect screens.

Warranty

Connect Collection Screens come with a warranty of 5 years. The warranty period starts on the next day after your screen has been delivered to you. The warranty is only effective when the screen's installation guidelines have been followed during installation, when the product has been used as intended and when your Connect screen has been maintained according to the maintenance guidelines.

What to do when something goes wrong?

To benefit from the warranty during the appropriate guarantee time frame, you want to inform ASKIA about the imperfections that have showed up in 2 weeks time after their development. To do that send a composed case to ASKIA, bringing up the following:

- the name of the absonded item or detail
- a definite depiction of the shortcoming/deformity
- a photograp and a video of the issue/deformity.
- receipt, conveyance note or any other proof of purchase.

The replaced /repaired products are subject to the same terms an conditions as the new products are. The warranty does not exclude or limit your right to use other remedies based on the law or on your contract.

Contact for warranty questions and customer support:
contact@askiafurniture.ro
Your warranty provider is: ASKIA FURNITURE SRL

Active warranty

In order to be covered by the warranty, you have to maintain your Easy Slide desk at reasonable intervals. The warranty does not extend to the natural wear of the pod, or to the texture and shade differences in wooden surfaces when you have purchased your products or its details at different times (as an additional order).

The warranty becomeds invalid

When maintenance work has benn undertaken on the Easy Slide desk during the official warranty period by a service provider who is not licenced by ASKIA.

- when details have been added to the Easy Slide desk which have not been approved by ASKIA.
- when the faults or defects have appeared due to wrongful maintenance, product's misuse, or during relocation of the assembled product.
- when the Easy Slide desk has been subjected to mechanical damage.

How will it get fixed

During the active waranty period, ASKIA will repair or replace all defective details or products as fast as possible, but not later than within 60 days after the written claim has been accepted by ASKIA. The delivery of replacement parts (that are covered by the warranty) is subject to similar conditions that were in effect during the original delivery of the product.

Instructions

Connect is a family of screens that provide intimacy and visual separation. They can be configured in multiple ways depending on the customer's needs. Do not step on the screen

Instructions for maintenance:

Upholstery:

Remove dust with a vacuum cleaner with a fabric or upholstery attachment. Absorb any liquid spills with a paper towel and then wipe with a damp cloth and let the fabric dry. Clean up spills immediately after they happen.

CLEANING MATRIX

	Vacuum	Extraction cleaning	Dry clean (if looses cover)	Washable up to 60°C
wool	x	x	x	
blends	x	x	x	
polyester	x	x	x	x
trevira CS	x	x	x	x

DISINFECTION MATRIX

	Steam	Dry clean (if looses cover)	Alcohol based solution 70% / spray / wipes	Washable up to 60°C	Bleach – general disinfection: diluted 1:10 / spray and wipes
wool	x	x	x		x
blends	x	x	x		x
polyester	x	x	x	x	x
trevira CS	x	x	x	x	x

ASKIA

Eliade Tower,
Mircea Eliade No.18
RO-Bucharest, 012015

T +40 212 121 381
contact@askiafurniture.ro

www.askiafurniture.ro